

RAIN BIRD®

ESP-LXD Controller

Installation, Programming & Operation Guide





Symbols

 **NOTE:** Symbol is intended to alert the user to important operating, functionality or maintenance or installation instructions.

 **WARNING:** Symbol is intended to alert the user to the presence of electricity within the controller which may constitute a risk of electronic shock or other hazard.

 **CAUTION:** Symbol is intended to alert the user to important instructions or conditions that could seriously affect irrigation effectivity or controller operation.

 **DIAL:** Symbol indicates that the user is required to turn the dial on the controller to the appropriate setting in order to follow subsequent instructions as described in that section.

 **REPEAT:** Symbol indicates that a repetition of previous steps or actions may be required in order to continue or complete the controller programming process.

Safety Information

 **WARNING:** A circuit breaker or cutoff switch must be provided in the fixed wiring to isolate the controller.

 **WARNING:** The current date and time on the controller is retained by a long-life lithium battery, which must be disposed of in accordance with local regulations.

Regulatory Information

This equipment has been tested and found to comply with the limits for a Class B digital device, pursuant to Part 15 of the FCC Rules. These limits are designed to provide reasonable protection against harmful interference in a residential installation.

This equipment generates, uses, and can radiate radio frequency energy and, if not installed and used in accordance with the instructions, may cause harmful interference to radio communications. However, there is no guarantee that interference will not occur in a particular installation.

If the equipment does cause harmful interference to radio or television reception, which can be determined by turning the equipment off and on, the user is encouraged to try to correct the interference by the following measures:

- Reorient or relocate the receiving antenna.
- Increase the separation between the equipment and the receiver.
- Connect the equipment into an outlet on a circuit different from that to which the receiver is connected.
- Consult the dealer or an experienced radio/TV technician for help.

Changes or modifications not expressly approved by Rain Bird Corporation could void the user's authority to operate the equipment.

This product was FCC certified under test conditions that included the use of shielded I/O cables and connectors between system components. To be in compliance with FCC regulations, the user must use shielded cables and connectors and install them per instructions.

For technical assistance contact Rain Bird at 800 RAINBIRD (1-800-724-6247) U.S. and Canada

Visit us on the web at www.rainbird.com

Contents

Section A - Introduction & Overview	1
Welcome to Rain Bird	1
ESP-LXD Controller	1
Controller Features.....	1
Controls, Switches and Indicators.....	2
2-Wire Path Overview.....	3
Star Pattern.....	3
Loop Pattern.....	4
Decoders.....	5
Types of Decoders.....	5
Field Decoder Addresses.....	5
Basic Operation.....	6
Programming Overview.....	7
Irrigation Controller Definitions.....	7
Programs.....	7
Watering Days.....	7
Watering Start Time.....	7
Station Run Time.....	7
Programming Guide.....	7
Fill Out Programming Guide.....	7
Apply Decoder Address Labels.....	8
Storing the Programming Guide.....	8
Remote Programming.....	8
Programming Checklist.....	9
Set Up Hardware.....	9
Set Up Programs.....	9
Set Up Programs (Optional).....	9
Review Setup.....	9
Optional Setup.....	9
AUTO.....	10
Automatic Operation.....	10
Alarm Conditions.....	11
Decoder Address Alarms.....	11
FloWatch™ Alarms.....	11
Review Alarm Messages.....	11
Resetting the Controller.....	12
Optional Features.....	12
Station Expansion Module (ESP-LXD-SM75).....	12
Section B - Basic Programming.....	13
Set Current Date & Time	13
Program Select Switch	14
Select Program.....	14
Setup Wizards.....	14
Valve Types Setup.....	14
Master Valves Setup.....	16
Weather Sensors Setup.....	18
Set Up Decoder-Based Weather Sensors.....	18
Weather Sensors Bypassed/Active Switch.....	19
Local Weather Sensors.....	19
Custom Pause Sensors.....	19
Custom Prevent Sensors.....	19
Station Setup.....	20
Flow Sensors Setup.....	22
Set Up Rain Bird Flow Sensor.....	22
Set Up Custom Flow Sensor.....	23
Set Watering Start Times	25
Select Days to Water	26
Station Run Times.....	27

Section C - System Diagnostics	29
Test All Stations/Check System	29
Confirm Programs.....	29
Program Summary	29
Review Program.....	30
Program Run Time	33
Station Run Time	34
Test All Stations.....	35
2-Wire Path Diagnostics.....	36
Short Finding	36
Decoder Test.....	38
Line Survey.....	40
Ping Decoders	42
Weather Sensor Status.....	44
Master Valve Status	45
Section D - Advanced Programming.....	47
Seasonal Adjust %.....	47
Adjust Individual Program.....	47
Adjust By Month.....	48
Select Months to Adjust	48
Select Programs To Adjust.....	49
Delay Watering	50
Rain Delay	50
Calendar Day Off.....	51
Water Windows	52
Set Up Water Window.....	52
Watering Cycles	53
Watering Cycle Definitions.....	53
Custom, Odd, Odd no 31st, Even	53
Cyclical Days.....	55
Station Settings.....	56
Set Up Cycle+Soak™	56
Set Up Station Delay.....	57
Set Up SimulStations™	58
Set SimulStations™ for Program.....	58
Set SimulStations™ for Controller.....	59
Station Sequencing.....	60

Section E - Options & Special Features	61
Backup and Recall Programs	61
Store Default Programs.....	61
Recall Default Programs.....	62
Delayed Recall	63
Programming Backup Cartridge (PBC-LXD).....	64
PBC-LXD Features	64
Barcode Scanning Feature.....	64
Installing a PBC-LXD	65
Backup Programs to PBC-LXD.....	66
Restore Programs from PBC-LXD.....	67
Decoder Barcode Scanning	68
Install Barcode Scanning Pen.....	68
Set Up Barcode Scanning Pen	70
Test Barcode Scanning Pen	71
Scan Field Decoder Addresses	72
Special Features	74
Set Language	74
Set Hours Mode	74
NOMV Cycling.....	75
Section F - Flow Management.....	77
Introduction to Flow.....	77
FloZones™ Overview.....	77
ESP-LXD Flow Management Features.....	77
FloManager™ Overview	77
FloWatch™ Overview	77
Set Flow Units	78
FloManager™	78
Set Up and Use FloManager™	79
Enable (Or Disable) FloManager™	79
Set Flow Rates Manually	80
Set Station Rates.....	80
Set FloZone™ Rates	81

FloWatch™	82
Set Up and Use FloWatch™	82
Enable (or Disable) FloWatch™	83
SEEF and SELF Settings and Actions.....	84
Set Up and Configure SEEF and SELF.....	84
Learn Flow	87
Learn Flow Automatically (All Stations)	87
Learn Flow Automatically (Custom Stations)	88
View and Clear Flow Alarms.....	90
View Station Flow Alarms	90
View FloZone™ Flow Alarms	91
Clear Flow Alarms	92
View Flow Rates	93
View Flow Rates for Stations.....	93
View Flow Rates for FloZones™	94
View and Clear Flow Logs	95
View Current Flow.....	96
Clear Flow Rates.....	97
Section G - Auxiliary Operation.....	99
Module Status	99
Smart Module Status.....	99
Check Station Module(s)	99
Clear Programs	100
Clear Individual Program.....	100
Clear All Programs.....	101
Restore Defaults.....	102
Manual Watering	103
Start Station Manually	103
Start Program Manually	104
MV Water Window.....	105
Set Up MV Water Window.....	105
Manually Opening a MV	107
Test All Stations.....	108
OFF	110
Adjust Display Contrast.....	110
Turn Off 2-Wire Path.....	110
Close Master Valves.....	112

Section H - Installation	113
Install the Controller	113
Installation Checklist	113
Check Box Contents.....	113
Select Location for Controller	114
Gather Installation Tools	114
Access Controller Cabinet.....	115
Open or Remove Controller Front Panel	115
Mount Controller.....	116
Install Modules	117
Install LXD Decoder Module	117
Install Station Expansion Modules	118
Connect Field Wiring	118
Connecting the 2-Wire Cable.....	118
Connecting Power to the Controller	120
Connect Ground Wire	120
Connect Power Source	120
Complete Installation	122
Programming Under Battery Power	122
Connect Decoders to Field Wiring	123
Wire Splices	123
Field Decoder Connections.....	124
Master Valves and MV Decoders.....	124
Surge Protection and Grounding.....	125
Install Lightning Surge Protectors (LSP-1s)	125
Decoder Managed Flow Sensors.....	126
Connect Flow Sensors	126
Decoder Managed Weather Sensors	126
Local Weather Sensors.....	127
Connect Local Weather Sensors	127
Verifying Field Installation	127
Appendix	129
Electrical Requirement Code of Magnetic Solenoid	129
Master Valve and Pump Set-up Tips.....	130
Using a Field Decoder With a Pump Start Relay	130

this page intentionally left blank

Section A - Introduction & Overview

Welcome to Rain Bird

Thank you for purchasing your new state-of-the-art Rain Bird ESP-LXD controller.

For over seven decades Rain Bird has led the irrigation industry in meeting water management needs by providing the highest quality products and services available.

ESP-LXD Controller

Your new Rain Bird controller is designed to provide years of highly manageable irrigation control.

The ESP-LXD is an irrigation controller designed for commercial use. It accommodates up to 50 stations and through the addition of Station Modules can easily be expanded to address up to 200 total stations.



Controller Features

The ESP-LXD controller has a variety of advanced features to help you manage water efficiently, including:

- Flow, power, and priority management
- 2-Wire and controller-based diagnostics
- Large variety of user-configurable irrigation program options to meet the most demanding irrigation needs while still addressing municipal mandates and restrictions
- Upgrade features including Station Modules, Programming Backup Cartridge (PBC), IQ Central Control Communication and ET Manager Cartridges.
- Supports one local and three decoder-based sensor inputs.
- Outdoor-rated plastic cabinet which can be upgraded to the optional metal cabinet (LXMM) and pedestal (LXMMPED).
- UL and CE certified.

Controls, Switches and Indicators

Key operational features of the ESP-LXD Controller front panel:

1 Programming Dial

Used for programming and to turn the controller on and off.

2 Weather Sensors Switch

Set the controller to obey or ignore input from optional sensors. See Section B, Weather Sensors Setup for more details.

3 Program Select Switch

Select watering Program A, B, C, or D. See Section B, Program Select Switch for more details.

4 Display

Displays time of day during normal operation; shows commands during programming; shows active station and remaining run time during watering

5 Programming Buttons

Press buttons to enter and change program information.

- Press and HOLD buttons to accelerate settings for hours, minutes and seconds, dates or percentages.

6 Alarm Light

Illuminates to indicate various types of alarm conditions. See Alarm Conditions for more details on how to review and clear alarms).

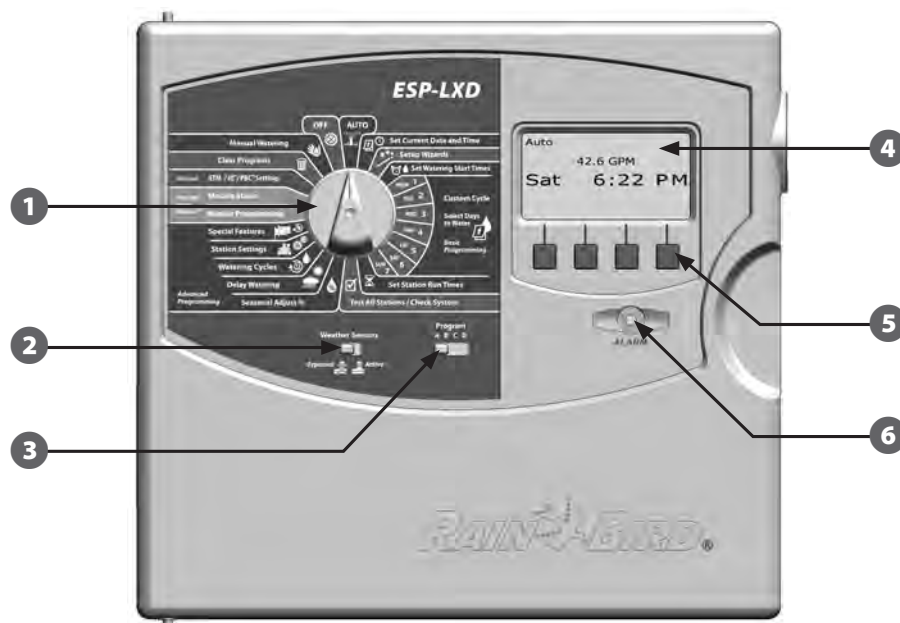

ESP-LXD Controller Front Panel Features

2-Wire Path Overview

The ESP-LXD controller with 2-Wire path has some key advantages over traditionally wired controllers.

In a traditionally wired system, separate wires are required for each valve which can be no further than a few hundred yards or meters from the controller.

The ESP-LXD utilizes a 2-Wire electrical path, upon which decoders can be attached at any location. This allows greater design flexibility and significantly greater distances to be supported. Valves in a two wire system can be managed using up to 3.3 miles (5.5 Km) of total wire path. Two types of 2-Wire path designs are supported:

Star Pattern

A Star Pattern allows branching as often as necessary without ever looping the wire back to the controller.

This generally allows more design flexibility but at the expense of some distance. The distance from the controller to the farthest decoder is known as the critical path; the greatest distance supported with 14 AWG cable is 1.65 miles (2.66 Km).

! **NOTE:** The ESP-LXD controller has 8 connections for up to four separate 2-Wire paths.

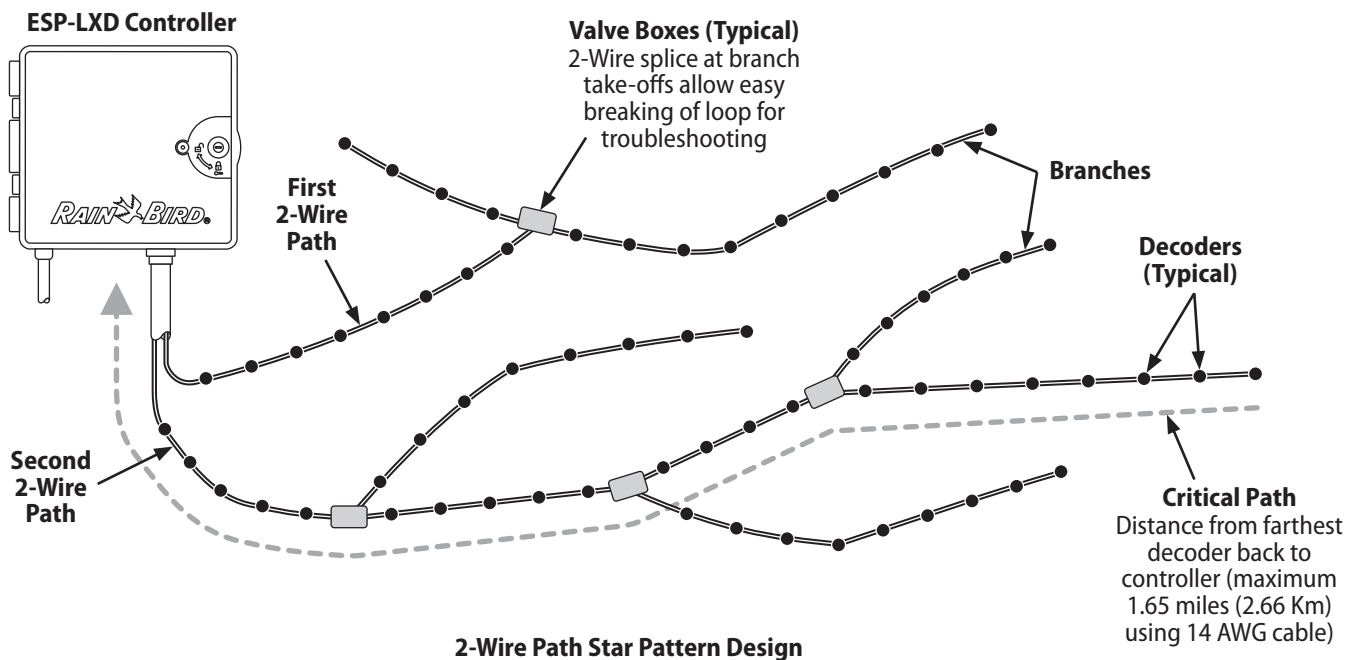

Loop Pattern

A Loop Pattern supports the greatest distance from controller to decoders.

However the Loop Pattern requires that the 2-Wire path loop back and return to the controller. The critical path for a Loop design is determined by calculating the distance around the loop to the farthest decoder and back to the controller. For both the Star and Loop designs, different distances can be supported with larger gauge cable.

Maximum Critical Path Lengths for 2-Wire Paths					
Nominal Wire Size	Ohms per 1000' or Ohms per Km (per conductor)	Max. Length For Critical Path			
		Star		Loop	
		Km	Miles	Km	Miles
2.5 mm2	7.5 Ohms/Km	3.00	1.86	12.00	7.46
14 AWG	2.58 Ohms/1000'	2.66	1.65	10.63	6.61
12 AWG	1.62 Ohms/1000'	4.23	2.63	16.93	10.52
10 AWG	1.02 Ohms/1000'	6.72	4.18	26.89	16.71

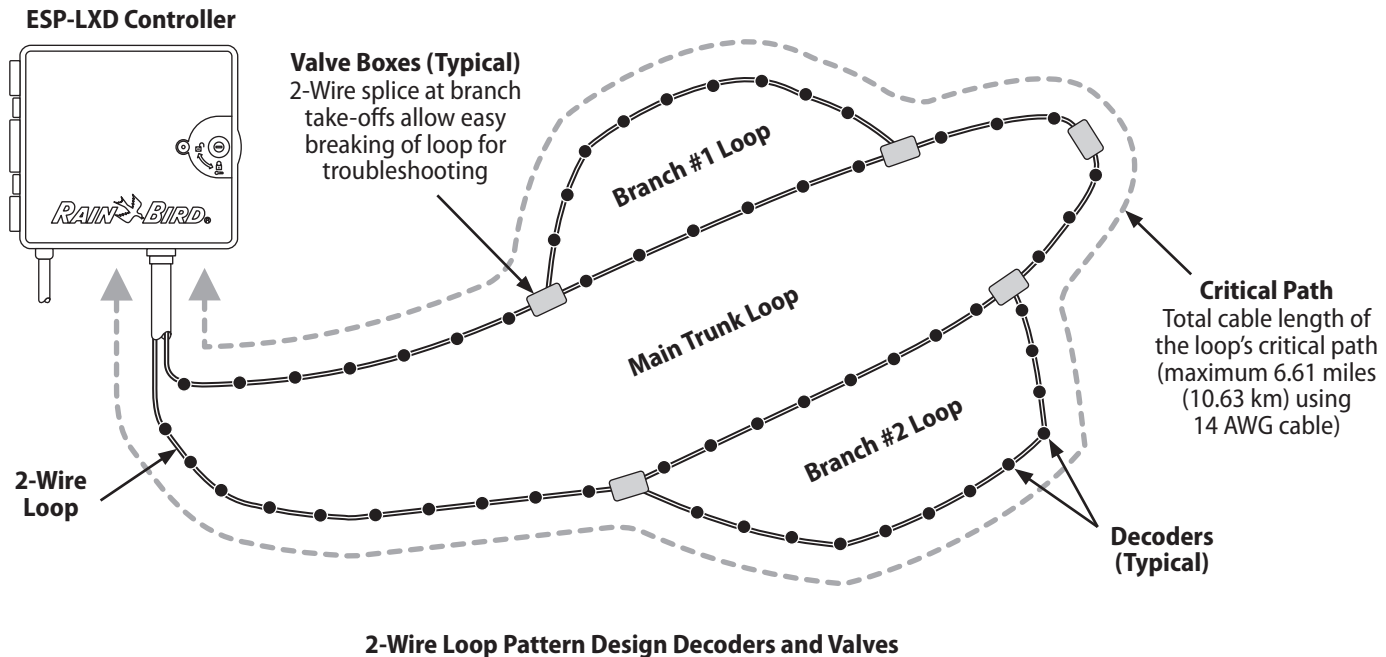

Decoders

The ESP-LXD controls your irrigation system using decoders.

A decoder is a device which attaches to the 2-Wire path and performs a task such as opening a valve for irrigation. Some, such as sensor decoders can be used to provide weather sensor status to the controller.

Typically a controller has several decoders connected, each with one or more valves attached. Valve outputs at the controller are called stations and are numbered sequentially. ESP-LXD controller is designed to keep track of your decoders so that once installed and set up all you have to do is manage irrigation for the various stations.

Types of Decoders

Field Decoders

Used to open and close valves for irrigation, these are the most commonly used decoders.

Master Valve (MV) Decoders

Used to open and close master valves. Both Normally Open master valves (NOMVs) and Normally Closed master valves (NCMVVs) are supported. The ESP-LXD controller can manage up to five Master Valves.

Weather Sensor Decoders

Used to provide an interface between the weather device and the controller. The ESP-LXD controller can support up to three weather sensor decoders.

Local Sensor

The ESP-LXD controller can also interface to a local sensor, such as a rain shutoff device. The local weather sensor connects directly to the ESP-LXD-M50 module via a separate wired or wireless connection rather than through a Sensor Decoder connected to the 2-Wire path. The ESP-LXD controller supports one Local Sensor.

Field Decoder Addresses

Field decoders have unique five digit address identifiers. Decoder addresses can be reprogrammed if necessary, using the Rain Bird DPU-210 Decoder Programming Unit.

Rain Bird Field Decoder Models			
Decoder Model	Number of Addresses Per Decoder	Maximum Number Of Solenoids Per Address	Maximum Addresses Operating At Once
FD-101	1	1	1
FD-102	1	2	1
FD-202	2	2	2
FD-401*	4	1	4
FD-601*	6	1	4

* Decoder includes Line Surge Protection.

Some decoders can support more than one valve. For example, an FD-102 decoder has a single address, but can control 2 different valves. However both valves would always have to open and close simultaneously since the FD102 only has a single address. An FD-401 could manage four valves, each independently since four addresses are available.

 **NOTE:** The ESP-LXD controller also supports setup by scanning decoder barcode labels using the optional Programming Backup Cartridge (PBC-LXD). See Section E for more details.

Valves (Stations)

Valves (or stations) operate at times as specified by irrigation programs.

The controller sends signals to the appropriate decoder, powering the valve solenoid to open or close. When additional stations are scheduled, another signal is sent to the next decoder and the cycle continues. For example, the controller sends the first decoder a signal to open its valve, allowing irrigation. When finished, the controller signals the decoder to shut off its valve and then signals the second decoder to open the valve. Then when the second station is finished, the third station will begin watering and so on.

! **NOTE:** The ESP-LXME's SimulStations feature allows you to operate multiple stations at the same time. See section D for more details.

! **NOTE:** The ESP-LXD's Cycle+Soak feature may delay valve operation. See Section D, Cycle+Soak for more details.

The ESP-LXD lets you set a delay between stations. For example, if you set a one minute delay, station 1 will run until finished, followed by a one minute delay. Then station 2 will run, followed by another one minute delay, and so on. See Section D, Station Delay for more details.

The order in which stations are selected to operate depends on the following settings:

- Station Sequencing settings
- Station flow rate (FloManager)
- Station priorities
- POC flow rate (FloManager)
- Station run times
- SimulStation settings
- Station program assignment

! **NOTE:** When using Station Sequencing by priorities, set station priorities higher for stations you want selected earlier in a program and lower for stations you want selected later in a program.

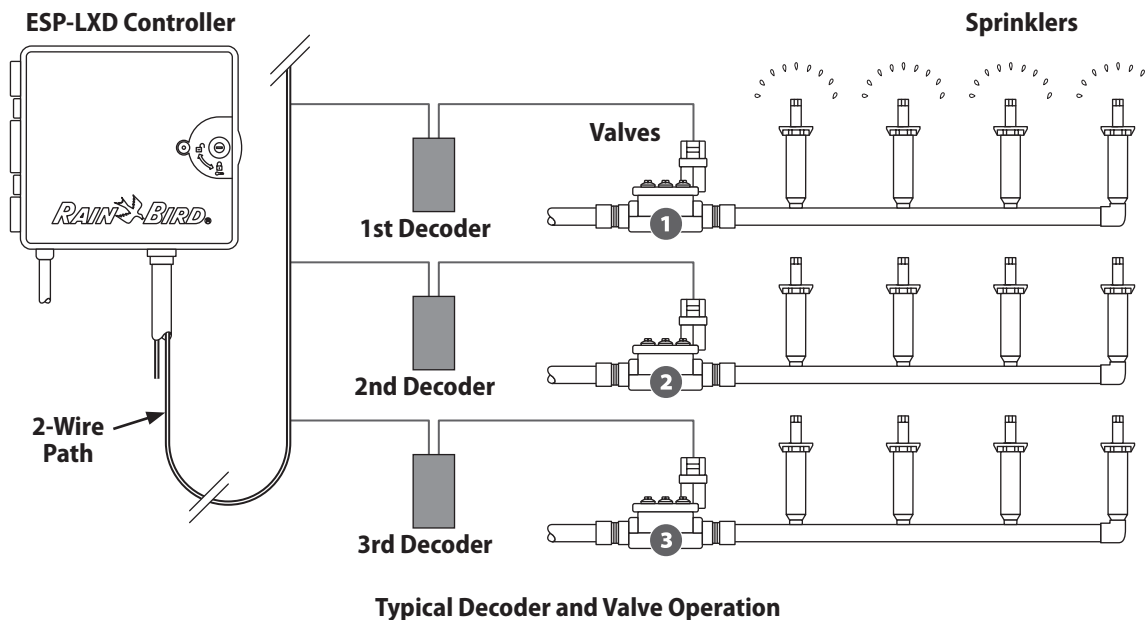

Programming Overview

Irrigation Controller Definitions

Programs

The process of telling the controller exactly when and for how long you want to water. The controller opens and closes the remote control valves according to a program you set.

Each program contains:

Watering Days

The days of the week or calendar dates on which irrigation is allowed. For example, specific days such as Monday, Wednesday and Friday could be designated as your “watering days”. Or else cyclical, such as every third day, or perhaps only on even or odd days of the month.

Watering Start Time

The time(s) of day that irrigation begins; this is the time that the first station in the program begins watering; all other stations in the program then follow in sequence.

! **NOTE:** The term “start time” refers to the time that a program starts, not to the time that each individual station begins to run.

Station Run Time

The length of time (in hours and minutes) that each individual station is programmed to run.

Programming Guide

Before you begin programming, fill out the Programming Guide. See the Programming Guide instructions for more details.

- 1 Locate the Programming Guide that came with the ESP-LXD controller.



Fill Out Programming Guide

- 2 Follow the instructions to enter information about your system hardware and settings in the appropriate fields on the Programming Guide.

Decoder Model	Station Uses MV	Station Flow Rate	Obey Local Sensor	Obey Weather Sensor
FD101	1 <input type="checkbox"/> 2 <input checked="" type="checkbox"/> 3 <input type="checkbox"/> 4 <input type="checkbox"/> 5 <input type="checkbox"/>	15	<input type="checkbox"/>	1 <input checked="" type="checkbox"/> 2 <input type="checkbox"/> 3 <input type="checkbox"/>
FD401	1 <input type="checkbox"/> 2 <input checked="" type="checkbox"/> 3 <input type="checkbox"/> 4 <input type="checkbox"/> 5 <input type="checkbox"/>	25	<input checked="" type="checkbox"/>	1 <input type="checkbox"/> 2 <input type="checkbox"/> 3 <input type="checkbox"/>

A circled number "2" with an arrow points to the "Station Uses MV" column in the table.

Continued on next page...

Apply Decoder Address Labels

- 3 Follow the instructions to apply station, master valve, flow and weather sensor decoder address labels in the appropriate fields on the Programming Guide.

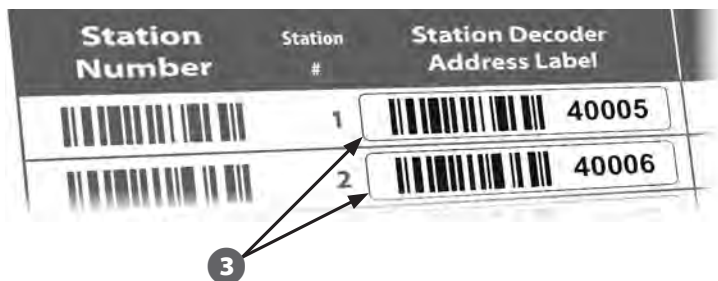

Storing the Programming Guide

Return the Programming Guide to a permanent, safe location when you're finished working with it. We recommend hanging it on the hook inside the controller cabinet door as shown below.



Remote Programming

The ESP-LXD controller can be programmed while operating under battery power.

This feature is useful if the controller is installed in an area that is not easily accessible. It also lets you enter program information before installing the controller at the job site. See Section H, Programming Under Battery Power for more details.

Programming Checklist

When programming the ESP-LXD controller for the first time, it is recommended that you complete the following steps in order.

For your convenience a check-off box is provided for each step.

Set Up Hardware

- Install LXD decoder module..... Page 117
- Install SM Station Modules..... Page 118
- Fill out Programming Guide (see Programming Guide instructions)
- Apply decoder address labels (see Programming Guide instructions)
- Clear program information..... Page 101
- Set language..... Page 74
- Set time..... Page 13
- Set date..... Page 13
- Set up valve types..... Page 14
- Set up master valves..... Page 16
- Set up weather sensors (optional)..... Page 18
- Set up stations and decoders..... Page 20
- Set up flow sensors (optional)..... Page 22

Set Up Programs

A B C D

- Select program (A, B, C or D)..... Page 14
- Set watering start times..... Page 25
- Select watering days *..... Page 26
- Set station run time(s)..... Page 27

* See Watering Cycles dial position for Odd, Odd31, Even and Cyclical watering cycles.

Set Up Programs (Optional)

- Set seasonal adjust..... Page 47
- Create a water window..... Page 52
- Set up a station delay..... Page 57
- Set up Simulstations..... Page 58

Review Setup

- Confirm program..... Page 29
- Test stations..... Page 35
- Check 2-Wire setup..... Page 36
- Check installed modules..... Page 99

Optional Setup

- Check weather sensor status..... Page 18
- Schedule calendar days off..... Page 51
- Create a MV manual water window..... Page 105
- Set Cycle+Soak..... Page 56
- Set flow units..... Page 78
- Activate FloManager..... Page 78
- Activate FloWatch..... Page 82
- Set up SEEF and SELF actions..... Page 84
- Set controller to AUTO..... Page 10

AUTO

Automatic Operation

The controller will operate automatically with the controller dial set to AUTO.

If you forget to return the dial to AUTO, the controller will automatically continue to run programs, unless the dial is set to the OFF position when all irrigation is canceled.

 Turn the controller dial to AUTO.



- 1 The Auto screen is displayed with the current day and time shown.
- 2 When a program is running in AUTO mode, the station number will display on the screen. Press the + or - buttons to add or subtract minutes from the run time for the currently running station. To advance to the next station in a program, press the Adv button.

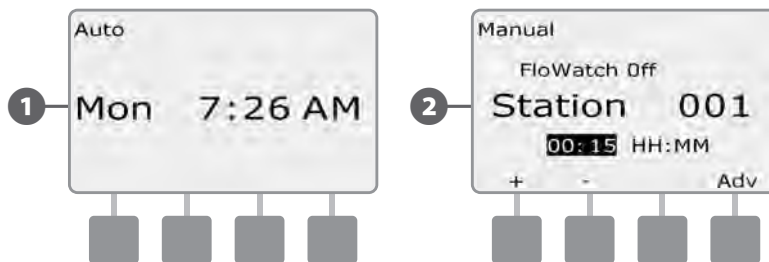

- 1  To cancel a currently running program, turn the controller dial to OFF for three seconds and then return the dial to AUTO.

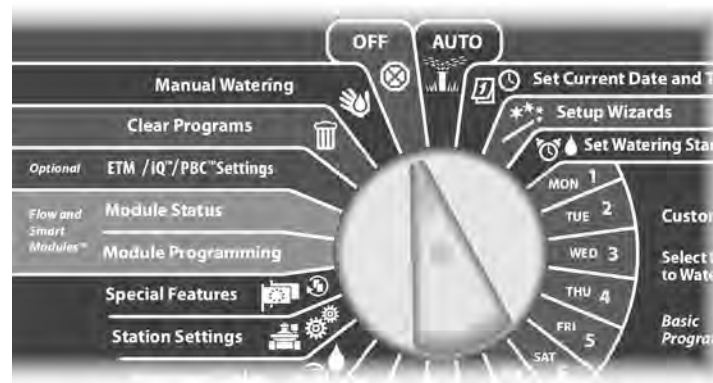

Alarm Conditions

An alarm condition can occur when programming omissions or other issues prevent normal irrigation.

Decoder Address Alarms

The controller will alarm if duplicate decoder addresses are entered for one or more weather sensors, flow sensors or stations. To clear the alarm, enter a different decoder address for one of the decoders. Only the first two duplicates will be shown, so you may need to repeat this process until all duplicate addresses have been cleared.

FloWatch™ Alarms

The controller will alarm for certain flow conditions if you have FloWatch set up. See Section F, Flow Management for more details.

Review Alarm Messages

- 1 When an alarm condition is detected, the alarm light on the controller front panel will illuminate.



- Turn the controller dial to AUTO.



- 2 When an alarm condition is present, the Alarm button label will be present on screen. Press the Alarm button to view alarm details.
- 3 Any present alarm conditions will then be displayed. Press the Next button if necessary, to advance to the next page.

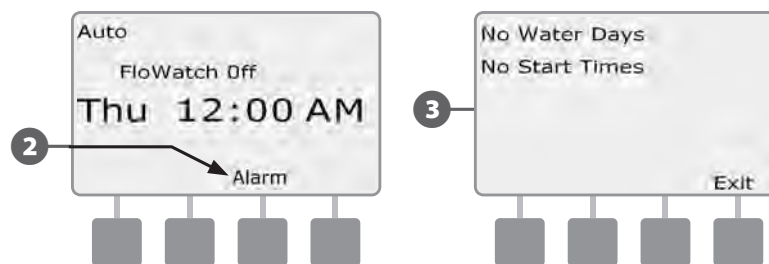

- !** **NOTE:** Take the appropriate action to address each alarm condition. When all alarms have been addressed, the alarm light on the front panel will no longer be illuminated.

Resetting the Controller

Sometimes you may want to reset (or reboot) the ESP-LXD controller. Using the controller's reset feature does not change or delete the programs you have loaded into the controller.

- 1 Turn the controller dial to AUTO.



- 3 Use a pen or pencil to depress the RESET button.
- 4 The "Rain Bird" screen appears, confirming reset.



Optional Features

Station Expansion Module (ESP-LXD-SM75)

The ESP-LXD controller comes standard with 50 stations available. This can easily be expanded by adding one or two optional ESP-LXD-SM75 Station Modules. Each station module adds 75 additional stations to increase capacity to 125 or 200 stations.

- 1 Open the controller outer cabinet door and inner front panel.
- 2 Locate the RESET button on the back of the front panel.

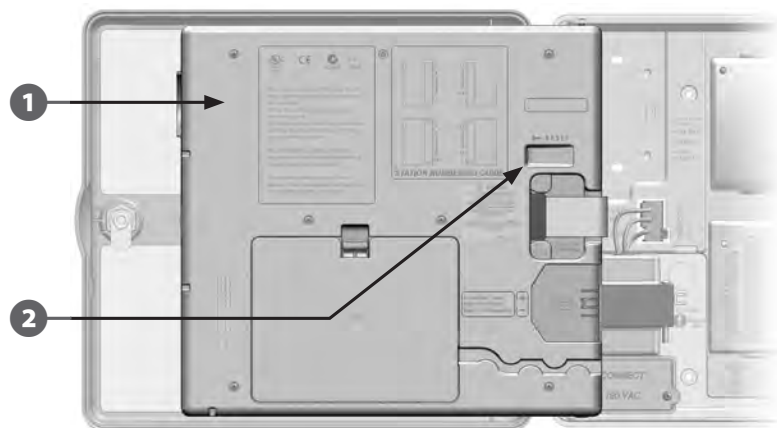

ESP-LXD-SM75 Station Expansion Module

Section B - Basic Programming

Set Current Date & Time

 Turn the controller dial to Set Current Date and Time.



1 The Set Date and Time screen appears. Press the + and – buttons to set the current hour; then press Next.

! **NOTE:** Be sure to set the hour correctly to either AM or PM.

- Press and HOLD buttons to accelerate settings for hours and minutes.

2 Press the + and – buttons to set the current minute; then press Next.

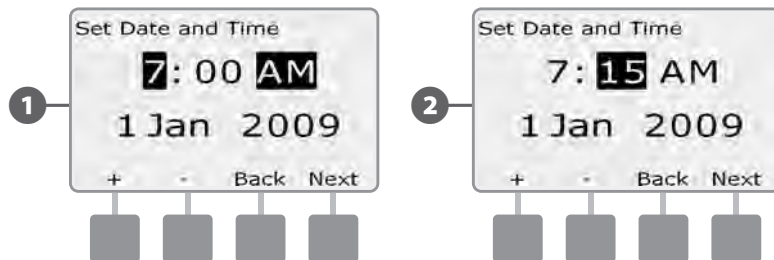

3 Press the + and – buttons to set the current day; then press Next.

4 Press the + and – buttons to set the current month; then press Next.

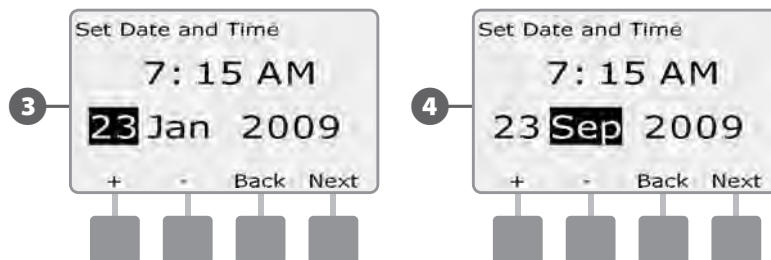

5 Press + and – to set the current year.



Program Select Switch

Always begin programming by setting the Program Select switch to the desired program.

Four independent Programs, A, B, C and D are available in the ESP-LXD controller. Multiple programs allow you to set watering schedules to meet different requirements for plant materials, soils, slopes, and shady or sunny areas. Programs can operate simultaneously with the only limitation being the number of stations you program to run simultaneously.

Select Program

On the controller front panel, slide the Program Select switch under the A, B, C, or D, then begin programming.



NOTE: When programming the controller, any program-specific information you enter, such as start times or watering days, will affect only the selected program.

Setup Wizards

Setup Wizards take you through each step for setting up your hardware in the ESP-LXD controller.

It's most effective to use the Setup Wizards in the order they appear on the screen: Valve Types, Master Valves, Weather Sensors (if present), Station Setup, and finally Flow Sensors (if present).

Valve Types Setup

The Valve Type Setup Wizard tells the ESP-LXD controller what types of valves are used by your irrigation system.

Up to five different valve types are supported by ESP-LXD, set up as V1, V2, V3, V4, and V5.

NOTE: It's not necessary to set up additional valve types if you're only using one or two types of valves at your job site.

Turn the controller dial to Setup Wizards.



- 1 The Setup Wizards screen appears with Valve Types selected; press Next.
- 2 The Valve Type Setup screen appears. Press the + and – buttons to choose a name for the first valve type (V1 is default); then press Next.

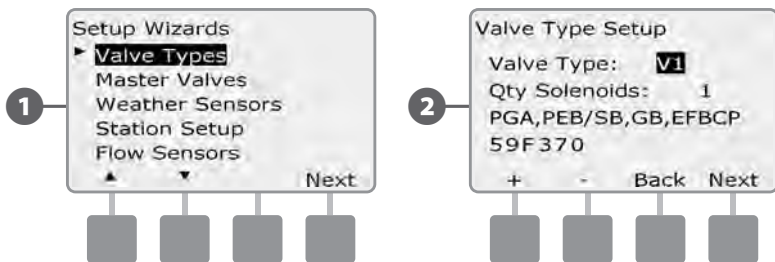

- 3 Press the + and – buttons to select the quantity of solenoids your V1 valve type supports; then press Next.

! **NOTE:** The default quantity of solenoids is 1, however some decoders can control 2 solenoids.

- 4 Press the + and – buttons to see the models of Rain Bird valves which the ESP-LXD supports. Select your valve type (if present); then press Next.

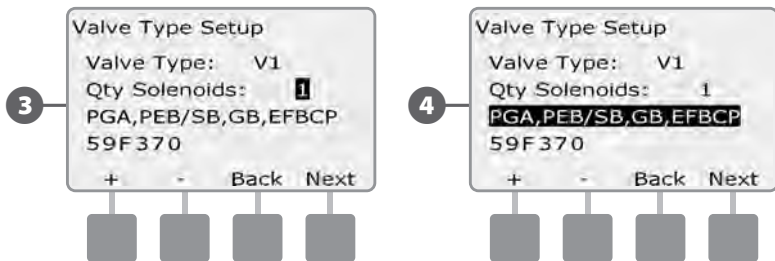

! **NOTE:** Rain Bird residential valves (DV and JTV series) are not compatible with ESP-LXD decoders. Use Rain Bird commercial valves (PGA, PEB, GB, EFB-CP and BPE series).

- 5 If you do not see your valve type, select Custom; then press Next.
- 6 Press the + and – buttons to enter the switch code for your valves.

! **NOTE:** For custom switch codes for non Rain Bird valves, contact the Rain Bird Global Support Plan group or see values in the Appendix.

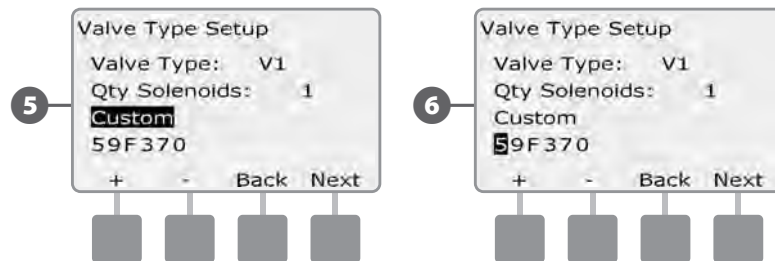

↻ Repeat this process to set up additional valve types.

! **NOTE:** Be sure to note each valve type on your Programming Guide for future reference.

Master Valves Setup

The Master Valves Setup Wizard tells the ESP-LXD controller what types of master valves (MVs) are used by your irrigation system.

The ESP-LXD supports up to 5 Master Valves or pumps. Each MV must be connected to a Field Decoder and set up in the controller. Both Normally Open master valves (NOMVs) and Normally Closed master valves (NCMV) are supported. Pumps are set up in the controller as Master Valves. If you are installing a pump, follow the instructions below, choosing the Pump Start Relay valve type in step 4. For wiring instructions for a pump please see Appendix B.

NOTE: Follow the previous instructions to set up valve types before setting up master valves.

Turn the controller dial to Setup Wizards.



- 1 The Setup Wizards screen appears. Press the Down Arrow button to select Master Valves; then press Next.
- 2 The Master Valve Setup screen appears. Press the + and – buttons to enter the desired MV number; then press Next.

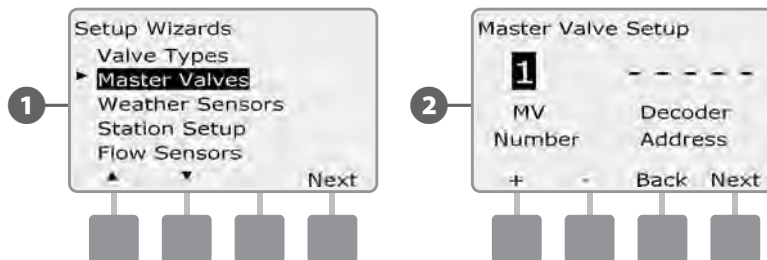

- 3 Press the + and – buttons to enter the decoder address, pressing Next and Back to navigate between the number setting fields; then press Next.

NOTE: An alarm will show if a duplicate master valve decoder address is entered for more than one MV. See Section A, Alarm Conditions for more details.

- 4 Press the + and – buttons to select the type of valve you're using for this MV; then press Next.

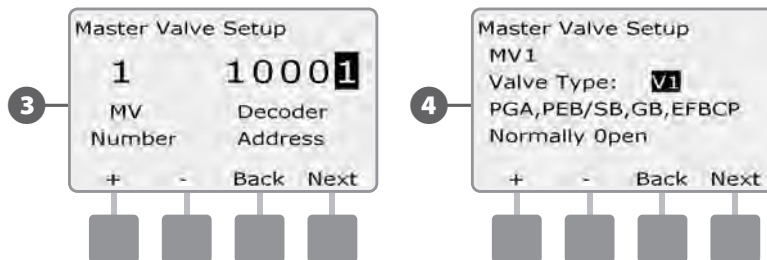

NOTE: Rain Bird residential valves (DV and JTV series) are not compatible with ESP-LXD decoders. Use Rain Bird commercial valves (PGA, PEB, GB, EFB-CP and BPE series).

- 5 Press the + and – buttons to select Normally Open or Normally Closed for the MV; then press Next.

! **NOTE:** Standard irrigation valves are Normally Closed (powered to open). Normally Open valves are specialty valves that are powered to close.

- 6 A confirmation screen appears asking you to assign MVs to FloZones; press Next to continue.

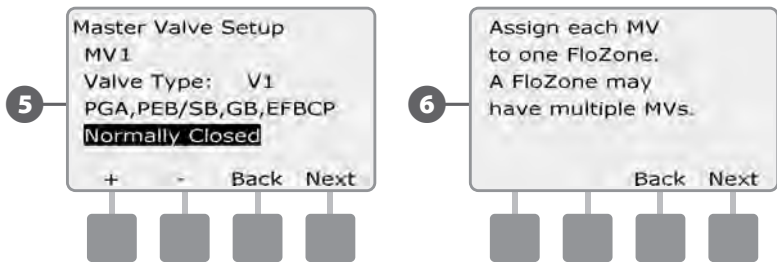

- 7 On the FloZone assignment screen, press the + and – buttons to associate the MV with the appropriate FloZone; then press Next.

! **NOTE:** A FloZone can use more than one MV as it's source(s), but an MV can only be assigned to a single FloZone.

- 8 The Shared MVs screen shows the other MVs associated with the selected FloZone.

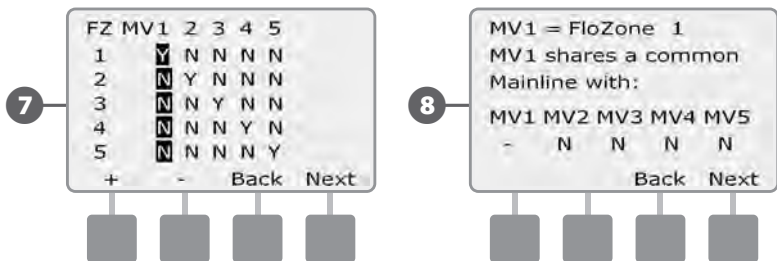

↻ Repeat this process to set up additional master valves. Be sure to note each MV on your Programming Guide for future reference.

Weather Sensors Setup

The Weather Sensor Setup Wizard tells the ESP-LXD controller what types of weather sensors are used by your irrigation system.

Weather sensors are not required for the ESP-LXD controller, but they increase functionality by allowing you to prevent or pause irrigation based on changing weather conditions. The ESP-LXD can support up to three decoder-based weather sensors and one local weather sensor. See Section H, Weather Sensor Installation for more details.

Set Up Decoder-Based Weather Sensors

▶ Turn the controller dial to Setup Wizards.



- 1 The Setup Wizards screen appears. Press the Down Arrow button to select Weather Sensors then press Next.
- 2 The Weather Sensor Setup screen appears. Press the + and - buttons to enter the desired weather sensor number; then press Next.



- 3 Press the + and - buttons to enter the decoder address, pressing Next and Back to navigate between the number setting fields; then press Next.

! **NOTE:** An alarm will show if a duplicate sensor decoder address is entered for more than one weather sensor. See Section A, Alarm Conditions for more details.

- 4 Press the + and - buttons to select the type of weather sensor. (Rain, Wind, Freeze and Soil moisture sensors are supported); then press Next.

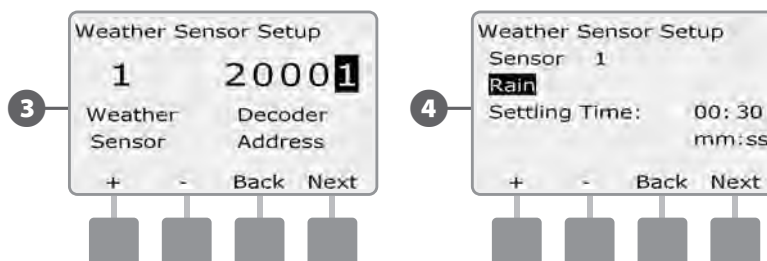

- 5 Press the + and – buttons to set the desired settling time; then press Next.

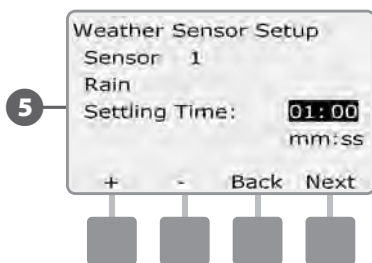

NOTE: Settling time is how long a weather condition must last before the controller takes action. For example, if a freeze sensor has a 5 minute settling time then the temperature would have to remain below the sensor's threshold set point for 5 minutes before irrigation is paused. Settling time can be set for immediate (0 seconds) or up to 10 minutes long.

Repeat this process to set up additional weather sensors. Be sure to note each weather sensor on your Programming Guide for future reference.

Weather Sensors Bypassed/Active Switch

You can set the controller to ignore or obey input from weather sensors. The Weather Sensors switch activates or bypasses all installed weather sensors on your system

- 6 On the controller front panel, slide the Weather Sensors switch to Bypassed (to ignore) or Active (to obey).



Local Weather Sensors

Follow the manufacturer's installation instructions. See Section H, Weather Sensor Installation for more details.

Custom Pause Sensors

When a weather condition becomes true, a Custom Pause sensor will stop irrigation and also stop the irrigation timer. When the condition becomes false again, irrigation will start exactly where it left off. For example, if a station is set to irrigate for 20 minutes but is shut down by a Pause sensor after only 5 minutes; when the weather condition becomes false again and after Resume, that station will receive the full remaining 15 minutes of irrigation left on the timer.

Custom Prevent Sensors

When a weather condition becomes true, a Custom Prevent sensor will stop irrigation but allow the irrigation timer to continue to run. When the condition becomes false again, irrigation will resume at the same time had the weather condition never occurred. For example, if a station is set to irrigate for 20 minutes but is shut down by a Prevent sensor after only 5 minutes, if the condition becomes false again after 10 minutes then that station will only receive the remaining 5 minutes of irrigation left on the timer.

Sensor Types	
Type	Action
Rain	Prevent
Wind	Pause
Freeze	Pause
Soil Moisture	Prevent
Custom Pause	Pause
Custom Prevent	Prevent

Station Setup

The Station Setup Wizard tells the ESP-LXD controller how many and what type of stations are used by your irrigation system.

Each valve within an irrigation system is referred to as a station. Be sure to note the location of each station on the Programming Guide so they can be set up correctly in the controller.

The ESP-LXD controller also supports station setup by scanning decoder barcode labels using the optional Programming Backup Cartridge (PBC-LXD). See Section E for more details.

NOTE: Before setting up stations, follow the previous instructions to set up valve types, master valves and weather sensors (if present).

Turn the controller dial to Setup Wizards.



- 1 The Setup Wizards screen appears. Press the Down Arrow button to select Station Setup then press Next.
- 2 The Station Setup screen appears. Press the + and - buttons to enter the desired station number; then press Next.

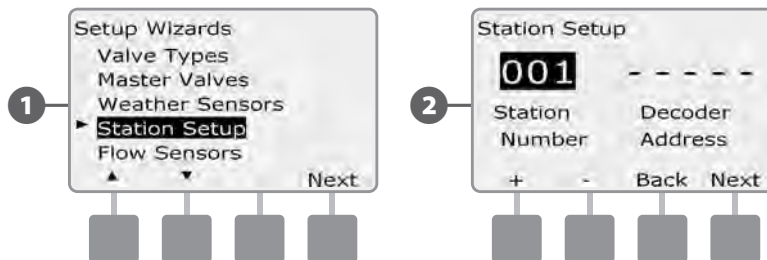

- 3 Press the + and - buttons to enter the decoder address, pressing Next and Back to navigate between the number setting fields; then press Next.

NOTE: An alarm will show if a duplicate decoder address is entered for more than one station. See Section A, Alarm Conditions for more details.

- 4 Press the + and - buttons to select the type of valve you're using for this station; then press Next.

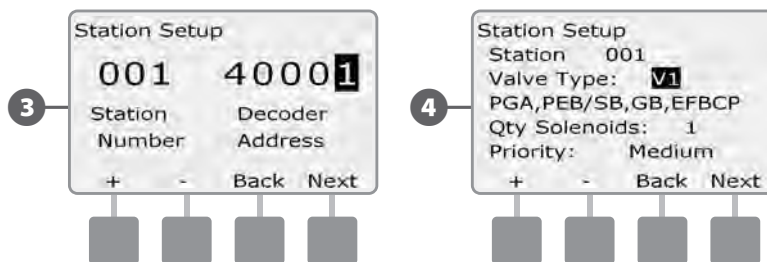

! **NOTE:** Station Priorities are only used when Station Sequencing is set to Sequence by Station Priority. If you're using the default Sequence by Station Numbers, then skip the next step by pressing Next.

5 Press the + and - buttons to set station priority. Each station can be set to high, medium, low or Non-irrigation. Station priority is especially important when multiple programs run simultaneously. The controller will run all high priority stations first, then all medium and finally all low priority, regardless of the station's program settings.

! **NOTE:** Non-irrigation stations such as fountains and landscape lighting receive priority to always run, regardless of weather conditions.

6 The FloZone Assignment screen lets you assign stations to FloZones if you're using either the FloWatch or FloManager features. Press the + and - buttons to see available FloZones, or if you're not using FloZones, select zero; then press Next.

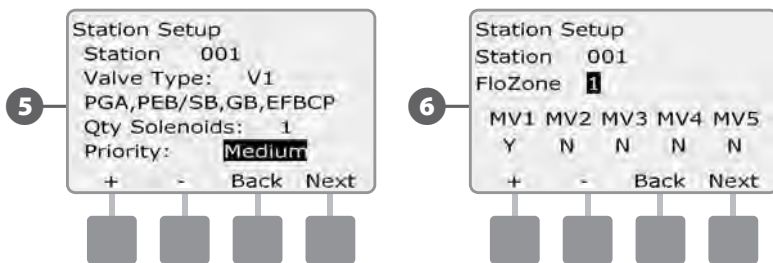

! **NOTE:** If you have already set up your MVs and FloZones, the MV assignments for the currently selected FloZone will be shown in the bottom portion of the screen.

7 The Weather Sensor Assignment screen lets you select which weather sensors a particular station will obey. Press the + and - buttons to set Y, for weather sensors which that station should obey, or set N, for sensors which that station should ignore. Press Next and Back to navigate between the WS fields.

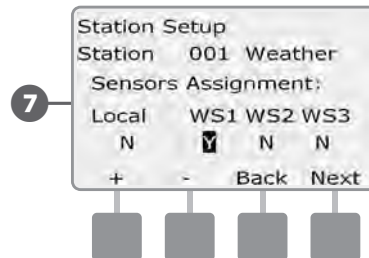

! **NOTE:** All weather sensors, both decoder-based and local, can be turned on (Active) or off (Bypassed) using the Weather Sensors switch on the controller front panel. See Weather Sensors Setup for more details.

↻ Repeat this process to set up additional stations.

Flow Sensors Setup

The Flow Sensor Setup Wizard tells the ESP-LXD controller what flow sensors are used by your irrigation system.

Flow sensors are not required for the ESP-LXD controller, but they add functionality by alerting you to abnormally high or low flow rates and even shutting down affected MVs or stations if flow rates exceed set thresholds. The ESP-LXD can support up to five flow sensors.

Set Up Rain Bird Flow Sensor

Turn the controller dial to Setup Wizards.



- 1 The Setup Wizards screen appears. Press the Down Arrow button to select Flow Sensors; then press Next.
- 2 The Flow Sensor Setup screen appears. Press the + and – buttons to enter the desired flow sensor number; then press Next.

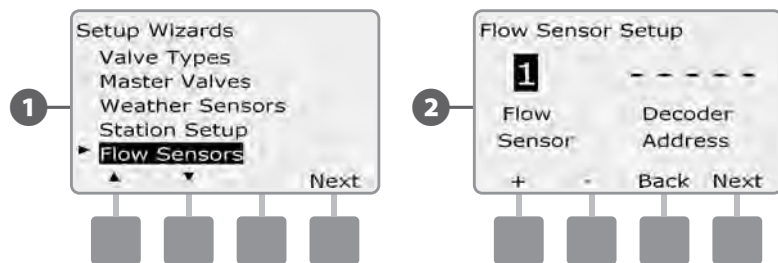

- 3 Press the + and – buttons to enter the decoder address, pressing Next and Back to navigate between the number setting fields; then press Next.

NOTE: An alarm will show if a duplicate sensor decoder address is entered for more than one flow sensor. See Section A, Alarm Conditions for more details.

- 4 Press the + and – buttons to select the Rain Bird flow sensor model that you're using.

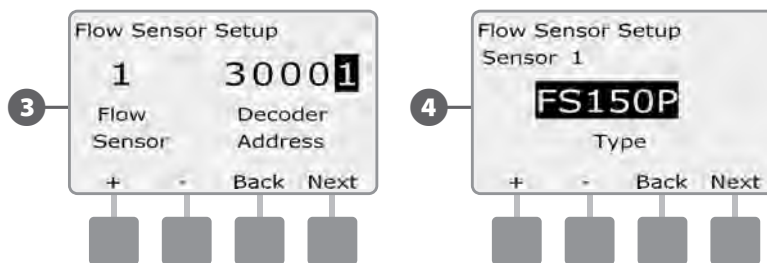

- 5 Press the + and – buttons to enter the MV you wish to assign to the flow sensor. Each assigned FloZone will be shown below the MV field.

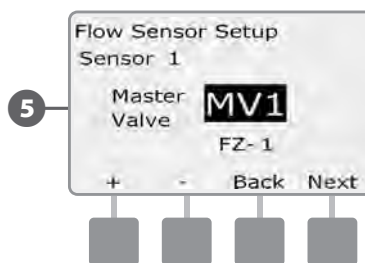

Repeat this process to set up additional flow sensors. Be sure to note each flow sensor on your Programming Guide for future reference.

Set Up Custom Flow Sensor

- 1 Turn the controller dial to Setup Wizards.



- 1 The Setup Wizards screen appears. Press the Down Arrow button to select Flow Sensors; then press Next.
- 2 The Flow Sensor Setup screen appears. Press the + and - buttons to enter the desired flow sensor number; then press Next.

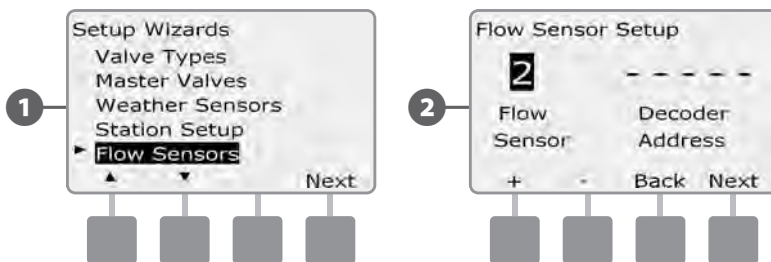

- 3 Press the + and - buttons to enter the decoder address, pressing Next and Back to navigate between the number setting fields; then press Next.

NOTE: An alarm will show if a duplicate sensor decoder address is entered for more than one flow sensor. See Section A, Alarm Conditions for more details.

- 4 Press the + and - buttons to select Custom; then press Next.

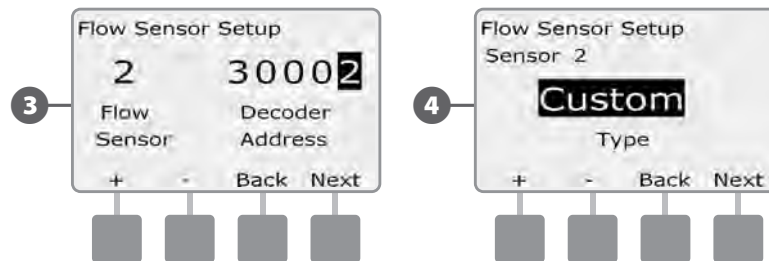

- 5 Press the + and - buttons to set the flow sensor K Factor, pressing Next and Back to navigate between the number setting fields; then press Next.
- 6 Press the + and - buttons to set the flow sensor Offset, pressing Next and Back to navigate between the number setting fields; then press Next.

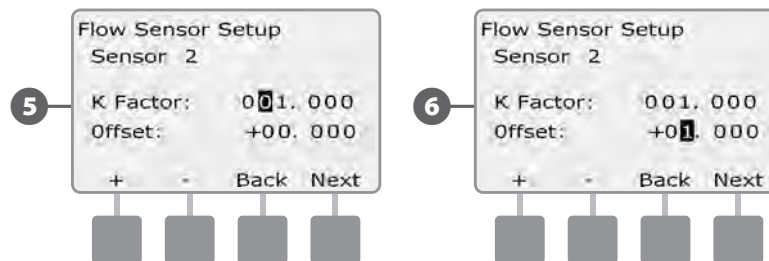

- 7 Press the + and – buttons to enter the MV you wish to assign to the flow sensor. Each assigned FloZone will be shown below the MV field.

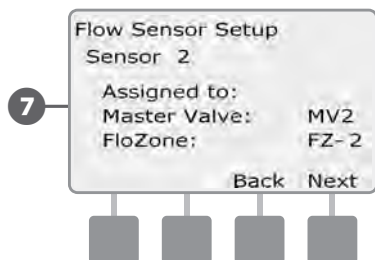

- Repeat this process to set up additional custom flow sensors. Be sure to note each flow sensor on your Programming Guide for future reference.

Set Watering Start Times

Start times are the time(s) of day that the program begins.

You can assign up to eight Start Times to a single program. Multiple Start Times allow you to run a program more than once on each day. For example, if you're growing new lawn seed, you may want to water several times a day to keep the seedbed or top dressing damp.

! **NOTE:** Start times apply to the entire program and not just to an individual station.

▶ Turn the controller dial to Set Watering Start Times.



1 The Set Start Times screen appears. Press the + and – buttons to set Start Time for the current program; then press Next.

- Press and HOLD buttons to accelerate settings for hours and minutes.

! **NOTE:** If the desired program is not selected, use the Program Select switch to change it. See Section B, Program Select Switch for more details.

2 Press the + and – buttons to set the start number (1 through 8).



↻ Change the Program Select switch and repeat this process to set up additional Watering Start Times for other programs as desired.

! **NOTE:** Cycle+Soak™ is an alternative method of dividing the total Station Run Time into smaller cycle times. If you plan to use Cycle+Soak, only a single Watering Start Time is required for each program. See Section D, Cycle+Soak for more details.

Select Days to Water

Watering Days are the specific days of the week on which irrigation is allowed to take place.

The ESP-LXD controller can be programmed to irrigate on different days, dates and cycles. Regardless of which Watering Cycle you set, the controller will only irrigate on the days or dates that you select. For additional information see Watering Cycles later in this section.

NOTE: The selections you make on the day positions of the controller dial will carry over to the Watering Cycles day settings and vice versa.

Turn the controller dial to Mon 1.



1 The Custom screen appears. Press the Allow or Prevent buttons to choose whether or not to allow irrigation starts to occur for that day of the week.

NOTE: If the desired program is not selected, use the Program Select switch to change it. See Section B, Program Select Switch for more details.

2 Turn the controller dial to Tue 2 and repeat the process.

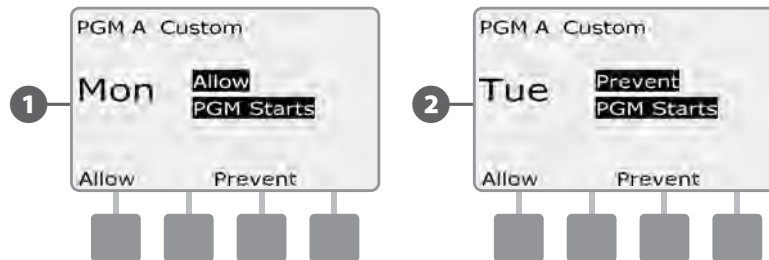

Repeat this process for all other days of the week in the program. Then change the Program Select switch and repeat this process to select Days to Water for other programs as desired.

Station Run Times

Run Times are the number of minutes (or hours and minutes) that each station runs.

Once your stations are set up, you will want to assign irrigation Run Times for each one. Station Run Times are particular to programs; so typically stations are set for a single program.

- Turn the controller dial to Set Station Run Times.



- ➊ The Set Run Times screen appears. Press the + and – buttons to enter the station to program; then press Next.

! **NOTE:** If the desired program is not selected, use the Program Select switch to change it. See Section B, Program Select Switch for more details.

- ➋ Press the + and – buttons to set the Station Run Time. Range can be from 00 hours, 00 minutes (no Run Time) up to 24:00 hours.

- Press and HOLD buttons to accelerate settings for hours and minutes.

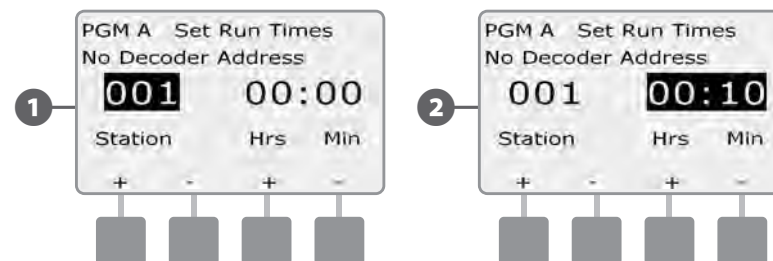

- ↻ Change the Program Select switch and repeat this process to set up additional Station Run Times for other programs as desired.

! **NOTE:** Seasonal Adjust % adjustments will adjust the Station Run Time down to the second. For example, if the Run Time is set for 1 minute and the Seasonal Adjust % is set to 50% then the adjusted Run Time equals 30 seconds.

this page intentionally left blank

Section C - System Diagnostics

Test All Stations/Check System

Review and confirm scheduled irrigation Programs, Program Run Times and Station Run Times.

Confirm Programs

The ESP-LXD controller can make calculations and provide feedback on Start Times and total Run Times for programs and stations.

Program Summary

Review program information for all programs:

- Turn the controller dial to Test All stations/Check System.



- The System Diagnostics screen appears with Confirm Programs selected; press Next.
- The Confirm Programs screen appears with Program Summary selected; press Next.

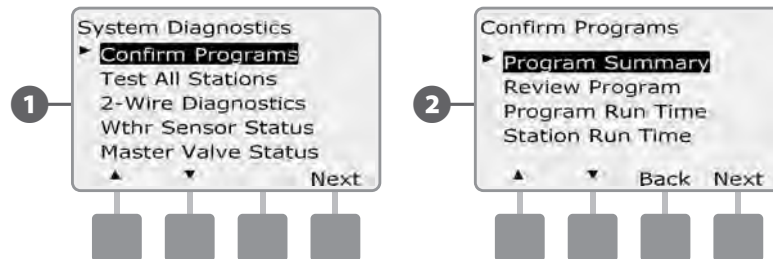

- The Program Summary screen appears, providing a summary of Run Times, Start Times and water days for all programs.

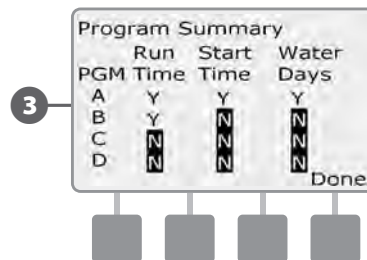

- NOTE:** In the above example, Program A will run because it has Station Run Times, Start Times and Watering Days all programmed, as indicated by the "Y" in each column for PGM A.

Program B however will not run as it is missing both the Start Time and Water Days programming, as indicated by the "N" in each of those columns for PGM B. Programs C and D will not run since both lack Station Run Times, Start Times and Watering Days.

Review Program

Review program information for a station:

- Turn the controller dial to Test All stations/Check System.



- The System Diagnostics screen appears with Confirm Programs selected; press Next.
- The Confirm Programs screen appears. Press the Down Arrow button to select Review Program; then press Next.

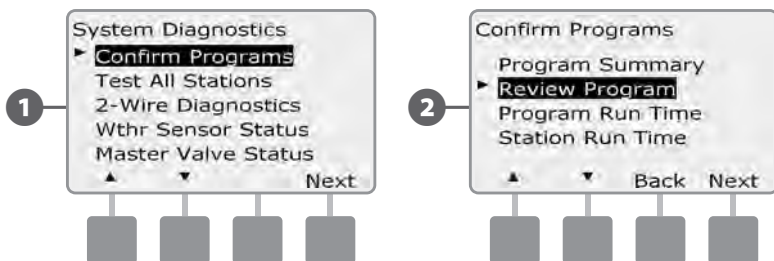

- The Watering Start Times review screen appears with start times displayed for the currently selected program. Press Next.

NOTE: If the desired program is not selected, use the Program Select switch to change it. See Section B, Program Select Switch for more details.

- The Watering Day Cycle review screen appears with the current watering day cycle displayed. Press Next.

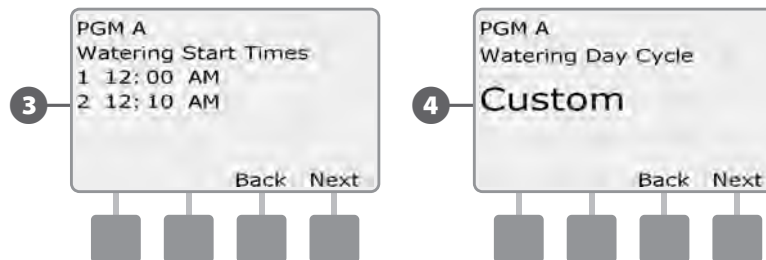

- The Watering Starts Allowed On review screen appears with allowed watering days displayed. Press Next.

- The Run Times review screen appears with run times for each station displayed. Press Next.

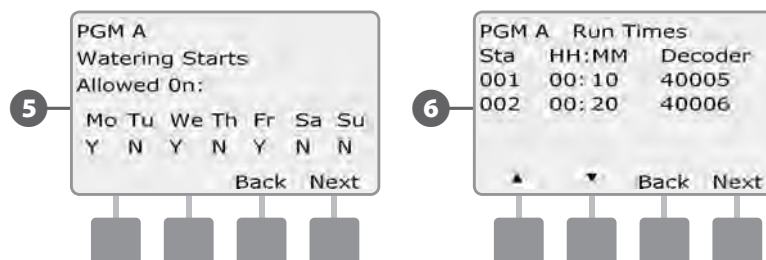

- 7 The Seasonal Adjust review screen appears with seasonal adjustment percentage displayed. Press Next.
- 8 The Seasonal Adjust by Month review screen appears with seasonal adjustment percentage displayed for the first allowed month. Press the + and - buttons to see Seasonal Adjust percentage for other months as desired; then press Next.

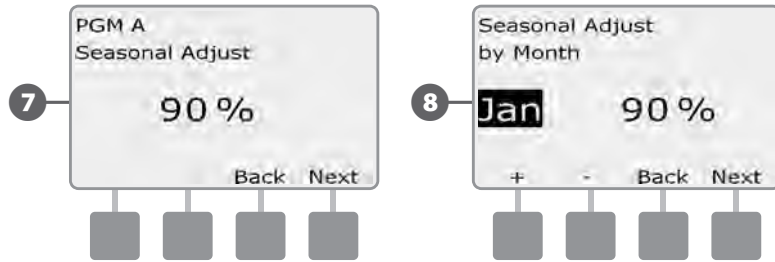

- 9 The Rain Delay review screen appears with number of days remaining until next watering date displayed. Press Next.
- 10 The Calendar Day Off review screen appears with all selected calendar days off displayed. Press Next.

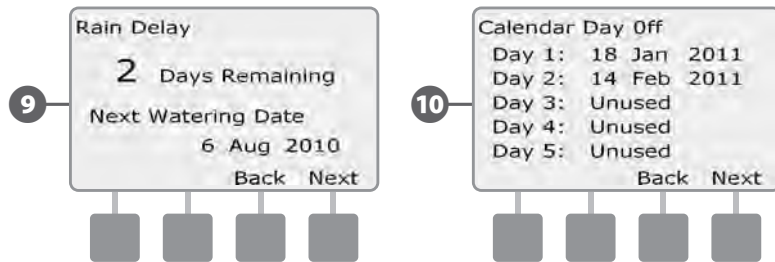

- 11 The Station Delay review screen appears with delay time between stations displayed. Press Next.
- 12 The Cycle+Soak Minutes review screen appears with the Cycle+Soak times for each station displayed. Press Next.

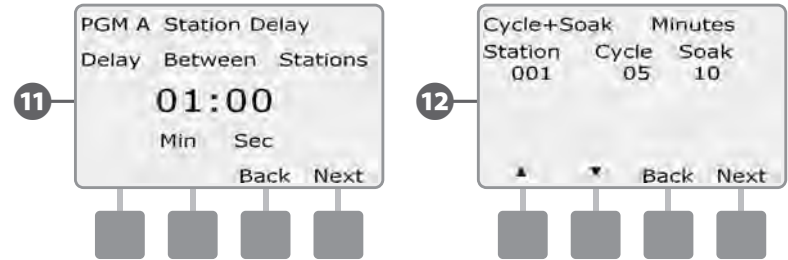

- 13 The Master Valve Assignment review screen appears with MV and associated FloZone information displayed. Press Next.
- 14 The Weather Sensor Assignment review screen appears with stations that use sensor override displayed. Press Next.

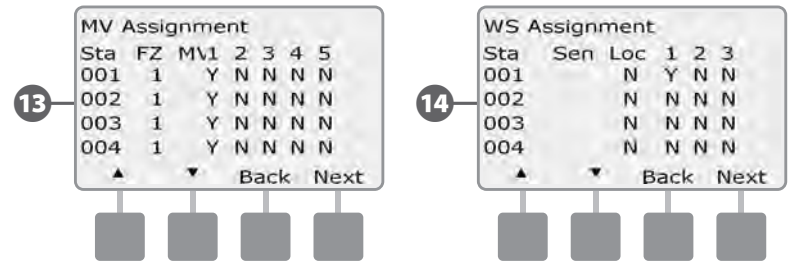

- 15 The Water Window review screen appears with water window open time, close time and duration displayed. Press Next.
- 16 The Maximum Number of SimulStations for program review screen appears with the maximum number of stations that can operate simultaneously for that program are displayed. Press Next.

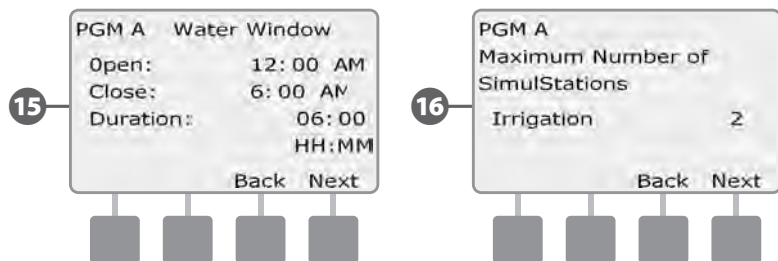

- 17 The Maximum Number of SimulStations for controller review screen appears with the maximum number of stations that can operate simultaneously for that controller are displayed. Press Next.
- 18 The Backup Programs review screen appears with the Contractor Default backup program status displayed. Press Next.

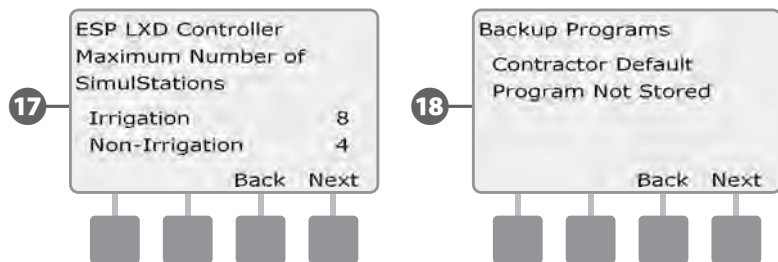

Program Run Time

Review total Run Time for an individual program:

- Turn the controller dial to Test All stations/Check System.



- 1 The System Diagnostics screen appears with Confirm Programs selected; press Next.
- 2 The Confirm Programs screen appears. Press the Down Arrow button to select Program Run Time; then press Next.

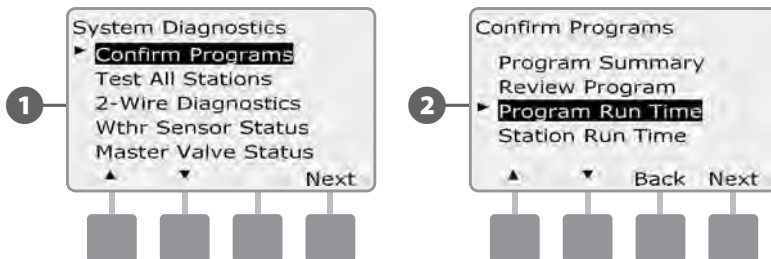

- 3 The Total Run Time screen appears and total Run Time is displayed for the currently selected program.

! **NOTE:** If the desired program is not selected, use the Program Select switch to change it. See Section B, Program Select Switch for more details.

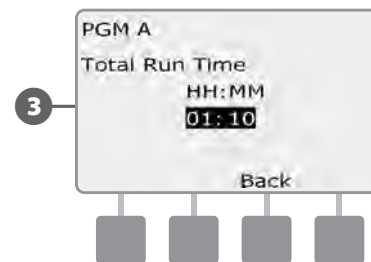

! **NOTE:** For stations set up for Cycle+Soak, the Cycle Time (when irrigation is occurring) will be included in Program Run Time calculations but Soak times will NOT be included. See Section D, Cycle+Soak, for more details.

↻ Change the Program Select switch and repeat this process to review and confirm Program Run Times for other programs as desired.

Station Run Time

Review total Run Time for all stations:

- Turn the controller dial to Test All stations/Check System.



- 1 The System Diagnostics screen appears with Confirm Programs selected; press Next.
- 2 The Confirm Programs screen appears. Press the Down Arrow button to select Station Run Time; then press Next.

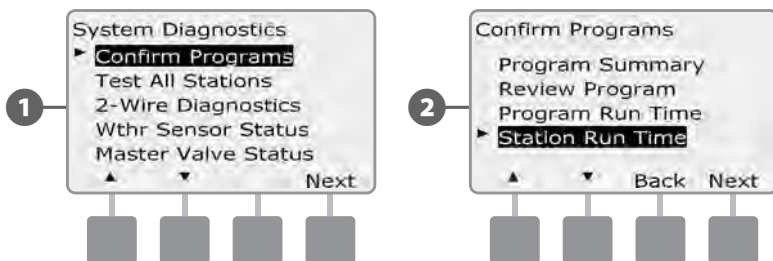

- 3 The Sta Run Time Per Day screen appears with total Run Time displayed for the currently selected station in all four programs. For programs where a particular station is not used no runtime will show.
- 4 Press the + and - buttons to advance and see additional stations.

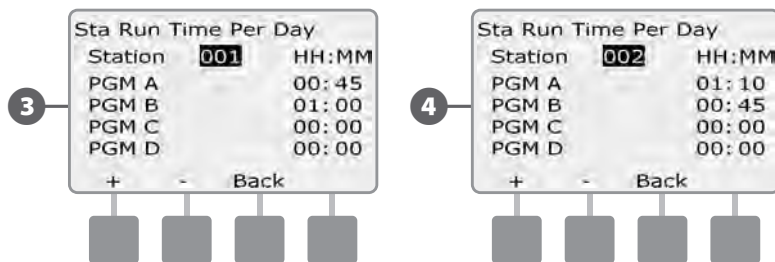

- !** **NOTE:** Soak times for stations set up with Cycle+Soak are not included in the Station Run Time calculations. See Section D, Cycle+Soak for more details.

Test All Stations

You can test all stations connected to your controller by running each of them in station number sequence.

Sometimes this is useful after installation, for general maintenance or as a first step in troubleshooting your system.

! **NOTE:** Only stations with programmed run times are included in the Test All Stations operation.

▶ Turn the controller dial to Test All stations/Check System.



- 1 The System Diagnostics screen appears. Press the Down Arrow button to select Test All stations; then press Next.
- 2 The Test All stations screen appears. Press the + and - buttons to adjust the Test Run Time (adjustable from 1 to 10 minutes) per station; then press Run.

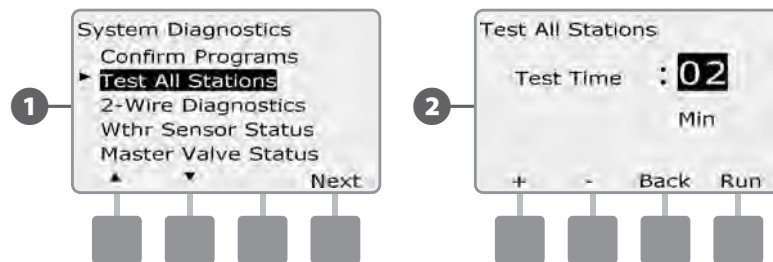

- 3 A confirmation screen appears.
- 4 Once Run is pressed, stations can be monitored and advanced by turning the dial to the AUTO position and using the Adv button. Press the + and - buttons to increase or decrease Run Time minutes for the current station.



2-Wire Path Diagnostics

Although finding the exact location of issues in the field often requires some amount of in-the-field troubleshooting with a clamp meter, the controller has some built-in features to help you narrow down the possible issues.

Before beginning 2-Wire path diagnostics, it may be helpful to take the following steps to eliminate possible other causes:

1. Review and Confirm Programs to check station priorities.

If a suspect station isn't watering as scheduled, the underlying issue could be programming-related. The ESP-LXD controller irrigates based on the station priorities. If multiple programs are running, higher priority stations will irrigate prior to medium priority stations, and medium priority stations will irrigate prior to lower priority stations. See Section B, Station Setup and Confirm Programs for more details.

2. Run a Test All Stations check to ensure valves are working properly.

The Test All Stations manual test will take priority above pre-programmed irrigation and allow you to determine which stations are working properly. See Test All Stations for more details.

Short Finding

The ESP-LXD controller can quickly determine if shorts are present on the two-wire path.

- ▶ Turn the controller dial to Test All stations/Check System.



- 1 The System Diagnostics screen appears. Press the Down Arrow button to select 2-Wire Diagnostics; then press Next.
- 2 The 2-Wire Diagnostics screen appears with Short Finding selected; press Next.

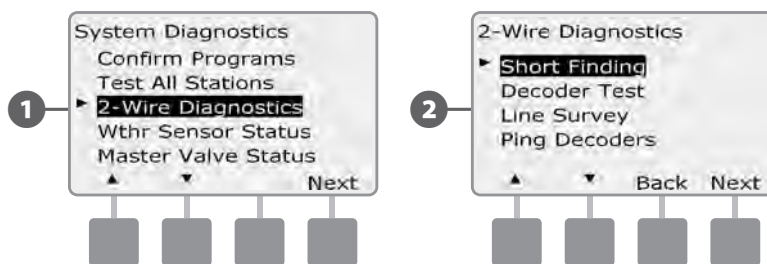

- 3 The Short Finding Mode screen will appear. Press the On button to begin the Short Finding process.
- 4 A confirmation screen appears to warn that irrigation will be disabled during the Short Finding process. Press and hold Yes to proceed with Short Finding.

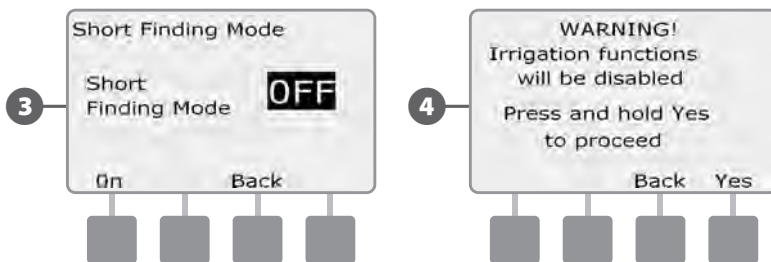

- 5 A confirmation screen appears, stating that irrigation has been disabled.
- 6 A second confirmation screen appears showing that Short Finding is now On and in progress.

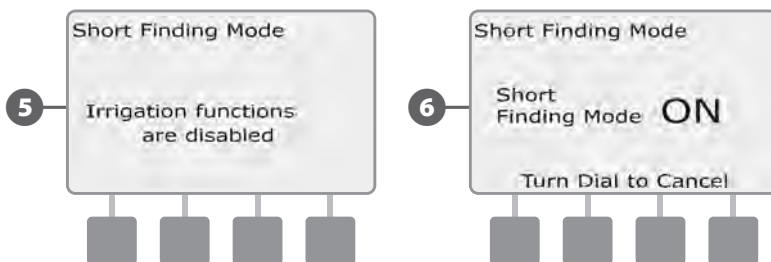

! **NOTE:** Use a clamp meter to isolate and repair shorts in the two-wire path. Once repairs are finished, be sure to return to the controller and turn the dial to exit short finding mode. Irrigation can not occur until short finding mode has been cancelled.

Decoder Test

The ESP-LXD controller may be able to provide specific information on particular decoders.

- Turn the controller dial to Test All stations/Check System.



- The System Diagnostics screen appears. Press the Down Arrow button to select 2-Wire Diagnostics; then press Next.
- The 2-Wire Diagnostics screen appears. Press the Down Arrow button to select station Decoder Test; then press Next.

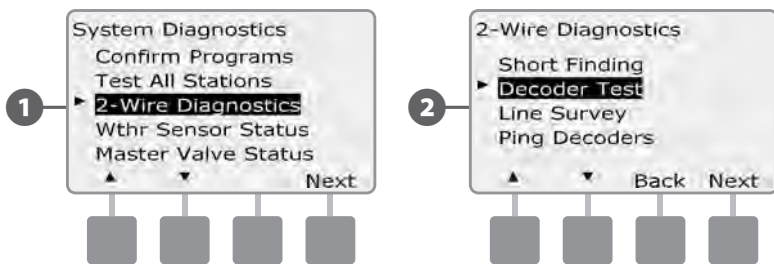

- A confirmation screen appears; press Start.
- A second confirmation screen appears to confirm the Decoder Test is In Progress.

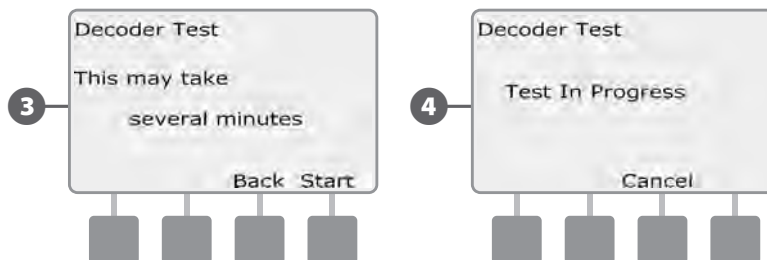

- The Decoder Test Result screen appears. If no issues are found, the screen will display a No Issues Found message; press Back.
- If the controller found issues with one or more decoders, the information will be displayed. If multiple issues are found, this may require more than a single screen. Press the Next button to continue through the issue screens, noting the issues as you go.

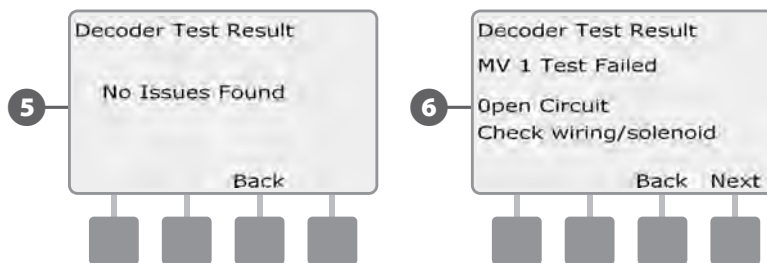

this page intentionally left blank

Line Survey

If you determine that one or more stations are not working properly, then before going into the field to address the issue you can take steps at the controller starting with a Line Survey.

Calculate System Amperage

For the Line Survey it's helpful to know what the total (approximate) amperage for your system should be. This can be estimated using the following formula:

System Amperage Calculation			
Quantity of single address station decoders	X	0.5 mA	
+ Quantity of multiple address station decoders	X	1.0 mA	
+ Quantity of active decoders	X	17.5 mA	
+ Quantity of other SD210 decoders	X	8.0 mA	
=		Approximate total system amperage (in mA)	

* Single address station decoders include the FD-101 & FD-102 decoders

** Multiple address station decoders include the FD-202, FD-401 & FD-601 decoders

Run a Line Survey

Once you have calculated the approximate amperage for your system, use the following steps to perform a line survey for your system:

- Turn the controller dial to Test All stations/Check System.



- ➊ The System Diagnostics screen appears. Press the Down Arrow button to select 2-Wire Diagnostics; then press Next.
- ➋ The 2-Wire Diagnostics screen appears. Press the Down Arrow button to select Line Survey; then press Next.

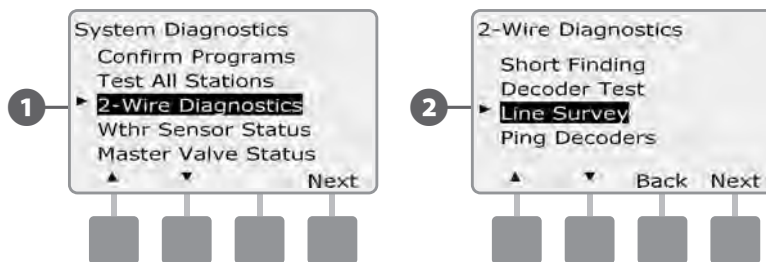

- 3 The Line Survey results will be displayed on a single screen.

3

Line Survey	A	B
Voltage1	-15.0	-35.0
Voltage2	22.1	22.3
Milliamps	0	0
Temp	Current	Overload
OK	Not OK	OK
Back		



If any of the Line Survey results are irregular, it's best to attempt to carefully check the 2-Wire path for short circuits and rerun the test. If you have checked your 2-Wire path and believe it to be in good condition, checking specific decoders can often help identify specific issues (see Ping Decoders below).

Interpreting Line Survey Results

A and B represent the two phases of the 2-Wire control system (not the two wires in the 2-Wire path). The Voltage1 reading for a normal healthy system is typically in the +14.0 to +16.0 range for both A and B. The Voltage2 reading is typically in the -20.0 to -21.0 range for both A and B. The Voltage1 reading should be approximately equal for A and B, and the Voltage2 reading should also be approximately equal for A and B.

If the Voltage1 or Voltage2 readings are 0.0 for either A or B, then one of the wires on the 2-Wire path are probably shorted to ground.

Milliamperage (mA) varies with the number of decoders installed on your system and should be approximately equal to the amperage calculations detailed above for both A and B.

Three flags also appear below the voltage and amperage readings. For a normal healthy system the flags should typically read OK; abnormal readings will cause the flag to change to Not OK.

If the temperature flag reads Not OK, discontinue irrigation and allow your system to cool for an hour or more before repeating the line survey.

If the Current or Overload flags read Not OK, short circuits within your 2-Wire path are typically to blame. However, a Not OK Current flag can also be due to one or more misconfigured decoders, and a Not OK Overload flag can be caused by a dead short.

Ping Decoders

The ESP-LXD controller can provide detailed information on a specific decoder.

This can be helpful to narrow a repair trip into the field to one decoder or a set of decoders on a particular branch of the two wire path. You can ping a Station decoder, MV decoder or Sensor decoder. Interpretation of the results is essentially the same for station and MV decoders.

Ping Station or MV Decoder

Turn the controller dial to Test All stations/Check System.



- 1 The System Diagnostics screen appears. Press the Down Arrow button to select 2-Wire Diagnostics; then press Next.
- 2 The 2-Wire Diagnostics screen appears. Press the Down Arrow button to select Ping Decoders; then press Next.

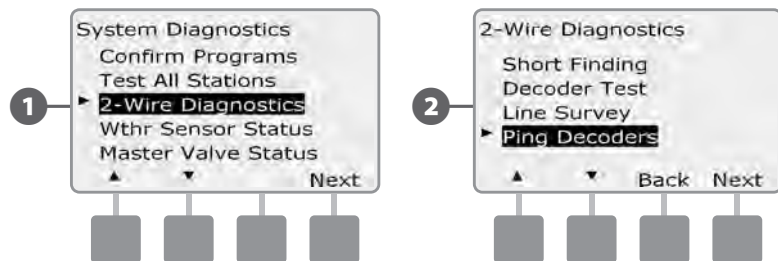

- 3 The Ping Decoder screen appears with Station Decoder selected. Press Next to ping a Station decoder (or else press the Down Arrow button to select MV Decoder); then press Next.
- 4 The Ping Station (or MV) Decoder screen appears. Press the + and - buttons to select the desired Station (or MV); then press Ping.

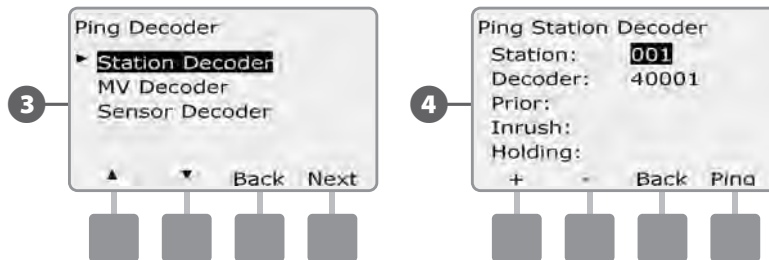

- 5 The controller will ping the selected decoder and report; amperage Prior to the ping, plus In-Rush and Holding current, all in milliamps.

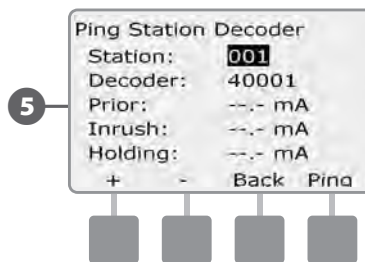

Interpreting Ping Results

- The Prior amperage is based on line current for your system and should be about the same as the previously Calculated System Amperage.
- The In-Rush current reading is typically less than 200 mA. A reading of 100 mA or less typically indicates an open output, often caused by a poor connection from the solenoid to the valve.

- The Holding current is typically 10 mA or less. A reading of 50 mA or greater typically indicates a shorted decoder output.

Ping Sensor Decoder

- ▶ Turn the controller dial to Test All stations/Check System.



- 1 The System Diagnostics screen appears. Press the Down Arrow button to select 2-Wire Diagnostics; then press Next.
- 2 The 2-Wire Diagnostics screen appears. Press the Down Arrow button to select Ping Decoders; then press Next.

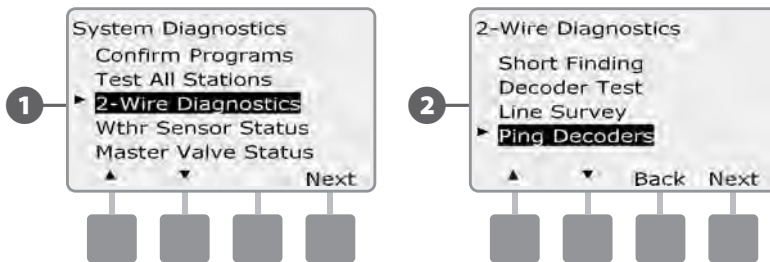

- 3 The Ping Decoder screen appears. Press the Down Arrow button to select Sensor Decoder; then press Next.
- 4 The Ping Sensor Decoder screen appears. Press the + and - buttons to select the desired Sensor; then press Ping.

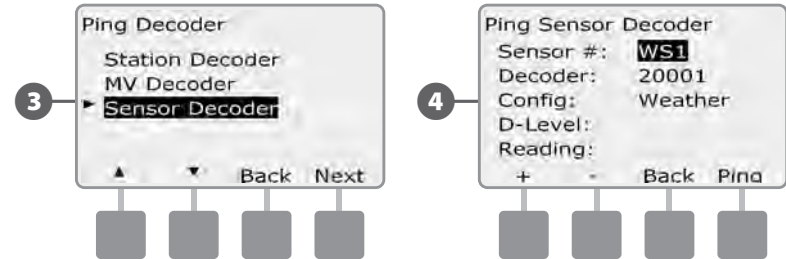

- 5 The controller will ping the selected sensor decoder and report the D-Level and Reading. Typically these will show as OK. If a Not OK reading is reported, check the connections to that sensor decoder or replace it.

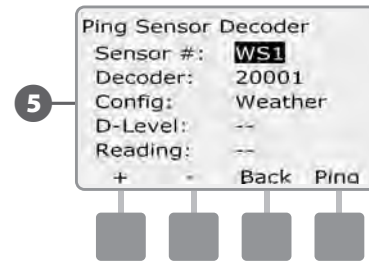

Weather Sensor Status

Turn the controller dial to Test All stations/Check System.



- 1 The System Diagnostics screen appears. Press the Down Arrow button to select Wthr Sensor Status; then press Next.
- 2 The Weather Sensor Status screen appears, showing installed weather sensors and their current status.

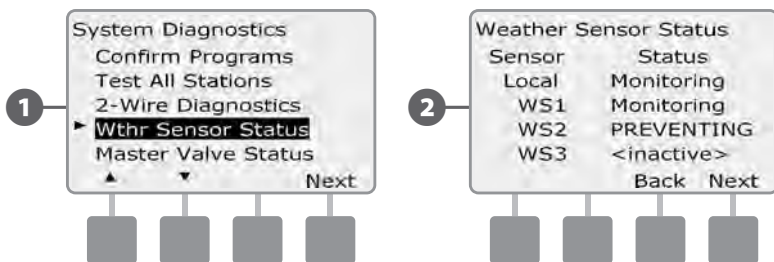

Each sensor will display one of five status conditions:

- a. Monitoring - sensor is active monitoring current weather conditions.
- b. <Inactive> installation has not been completed or the sensor is not linked to any stations.
- c. PAUSING - current weather condition has caused the sensor to pause irrigation.
- d. PREVENTING - current weather condition has caused the sensor to prevent irrigation.
- e. BYPASSED - sensor switch is in the Bypassed position and the sensor is not monitoring current weather conditions.

! **NOTE:** If current weather conditions are sufficient for a weather sensor to prevent or pause irrigation, then a message appears on the Auto screen. This is not considered an alarm, so the controller alarm light will not illuminate.

Master Valve Status

Turn the controller dial to Test All stations/Check System.



- 1 The System Diagnostics screen appears. Press the Down Arrow button to select Wthr Sensor Status; then press Next.
- 2 The MV Status screen appears, showing installed master valves and their current status.

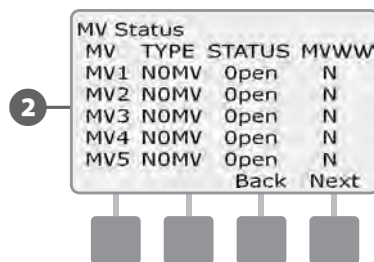
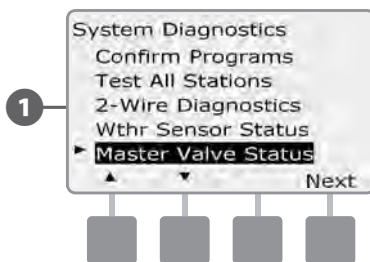

this page intentionally left blank

Section D - Advanced Programming

The ESP-LXD controller has a wide variety of advanced but easy-to-use features designed to simplify irrigation.

Seasonal Adjust %

Seasonal Adjust % allows you to use the heaviest irrigation season as a baseline and adjust to lesser amounts of watering at other times of the year. For example, you could set July at 100% and set October to 50% so there would be half as much watering in Fall than in Summer. Seasonal adjustments can be managed by month or by program.

CAUTION: Multiple Seasonal Adjustment settings affect each other and can significantly impact irrigation. For example, if you set a program-level Seasonal Adjustment of 10% and then a monthly Seasonal Adjustment of 10% then irrigation will be reduced to 1% of normal (10% of 10%). Consider using only one type of Seasonal Adjustment setting.

CAUTION: Setting a small number for the Seasonal Adjustment percentage will greatly reduce watering and setting to 0% will cancel irrigation entirely. Use caution when making Seasonal Adjustment settings.

NOTE: Do not use Seasonal Adjustments if you're already using an ET Manager Cartridge (ETC-LX) with your controller. The ETC-LX automatically manages Seasonal Adjustments. For more information consult the Rain Bird web site or the ETC-LX user documentation.

Adjust Individual Program

Turn the controller dial to Seasonal Adjust %.



1 The Seasonal Adjust screen appears with Individual PGM selected; press Next.

2 Press the + and - buttons to set the seasonal adjustment percentage (from 0 - 300%).

- Press and HOLD buttons to accelerate settings for percentages.

NOTE: If the desired program is not selected, use the Program Select switch to change it. See Section B, Program Select Switch for more details.

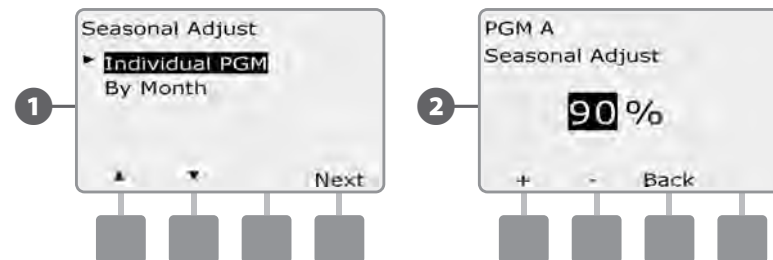

Change the Program Select switch and repeat this process to set Seasonal Adjustments for other programs as desired.

Adjust By Month

Select Months to Adjust

- Turn the controller dial to Seasonal Adjust %.



- 1 The Seasonal Adjust screen appears. Press the Down Arrow button to select By Month; then press Next.
- 2 The Seasonal Adjust by Month screen appears with % Adjust selected; press Next.

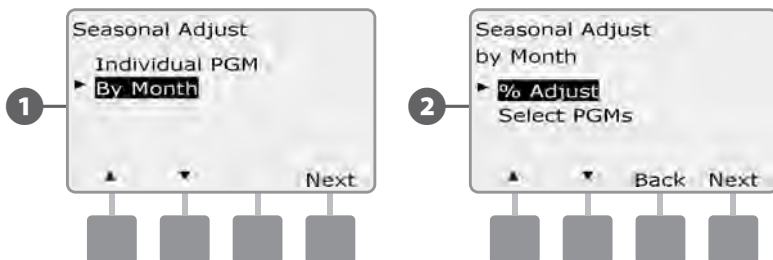

- 3 Press the + and - buttons to select the month you would like to adjust; then press Next.
- 4 Press the + and - buttons to set the Seasonal Adjustment percentage (from 0 - 300%).
 - Press and HOLD buttons to accelerate settings for percentages.

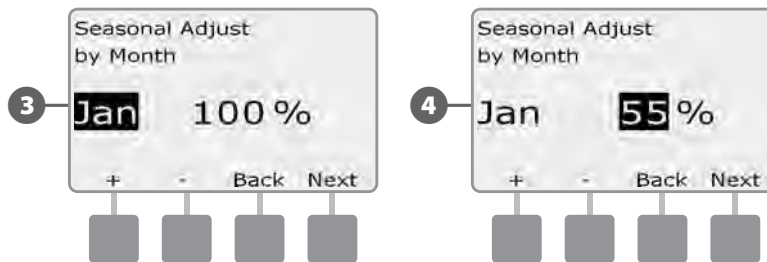

- Repeat this process to set Seasonal Adjustments for other months as desired. Then change the Program Select switch and repeat this process to set Seasonal Adjustments By Month for other programs as desired.

NOTE: The % Adjust will automatically change to the new month's percentage setting on the first day of the month.

Select Programs To Adjust

- ▶ Turn the controller dial to Seasonal Adjust %.

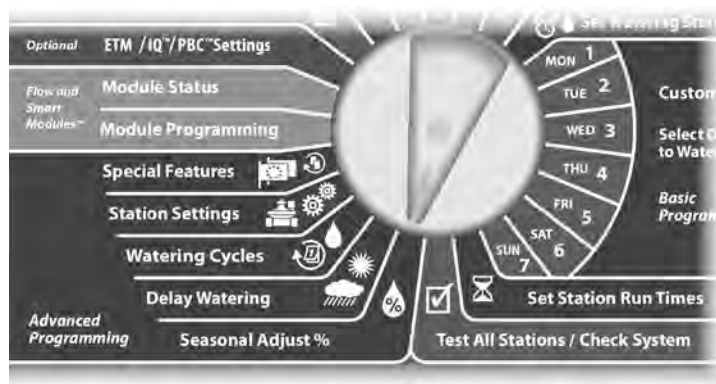

- 1 The Seasonal Adjust screen appears. Press the Down Arrow button to select By Month; then press Next.
- 2 The Seasonal Adjust by Month screen appears. Press the Down Arrow button to select Select PGMs; then press Next.

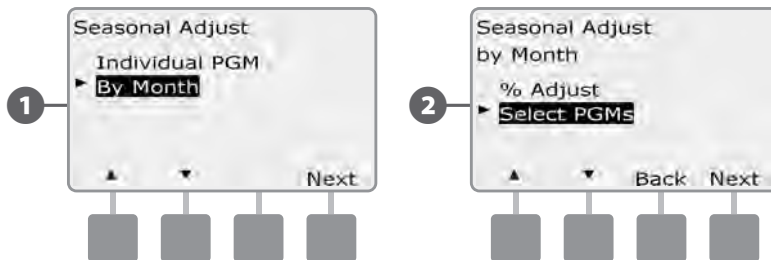

- 3 Press the Yes or No buttons to set Monthly Adjust for the current selected program.
- 4 To set another program, change the Program Select switch to the desired program; a confirmation appears.

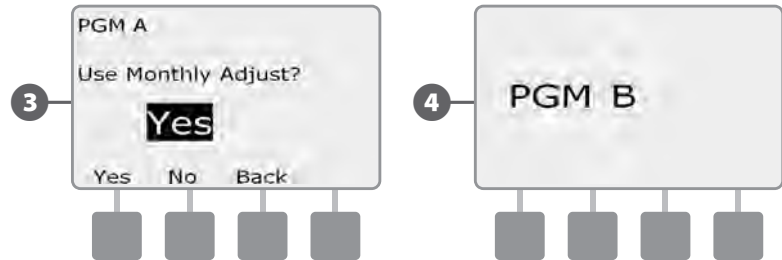

- ↻ Repeat this process to set Monthly Adjustments for other programs as desired.

Delay Watering

Rain Delay

The ESP-LXD controller's Rain Delay feature lets you discontinue irrigation for a few days after a period of heavy rain.

The ESP-LXD can also be equipped with an optional Rain Bird ET Manager Cartridge to automatically calculate and automate rain shutdown. Ask your Rain Bird distributor for more details or visit the Rain Bird web site, www.rainbird.com.

NOTE: If you have a rain sensor attached to your controller, it may be unnecessary to manually program a Rain Delay. Consult the rain sensor device documentation for more details.

▶ Turn the controller dial to Delay Watering.



- 1 The Delay Watering screen appears with Rain Delay selected; press Next.
- 2 The Rain Delay screen appears. Press the + and – buttons to set the number of days (from 0 to 14 days) for the Rain Delay. The next irrigation date after the Rain Delay calculates and displays automatically.

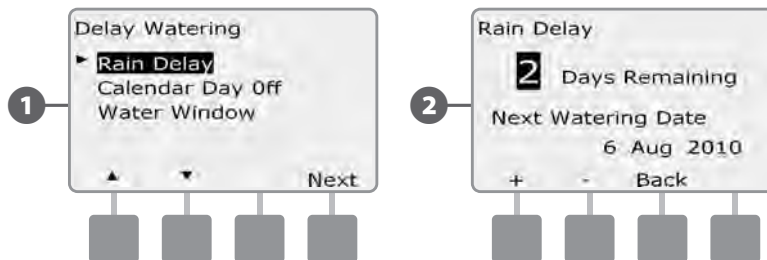

NOTE: A Rain Delay affects all programs, but stations set up as Non-irrigation will still run during a Rain Delay.

Calendar Day Off

You can schedule certain days of the year as Non-irrigation, such as holidays when landscape may receive heavy use.

The ESP-LXD controller can be programmed to suspend irrigation on a particular calendar date, up to 5 different days of the year.

! **NOTE:** Calendar Day Off dates can only be selected 365 days in advance. Then once a Calendar Day Off has passed, it will be removed from the list and must be reprogrammed for the following year if desired.

▶ Turn the controller dial to Delay Watering.



- 1** The Delay Watering screen appears. Press the Down Arrow button to select Calendar Day Off; then press Next.
- 2** The Calendar Day off screen appears, showing (up to 5) scheduled calendar days off in chronological order. Unprogrammed days will show as Unused.

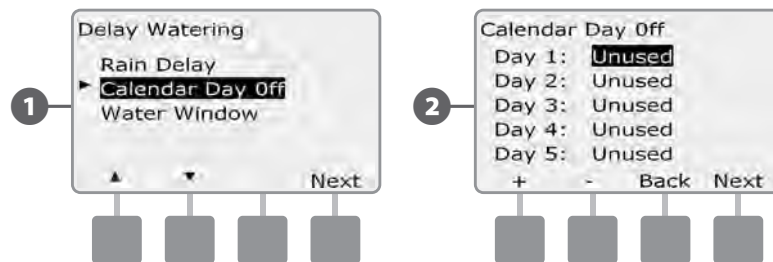

- 3** Press the + and - buttons to set the Calendar Day Off date as desired. Press the Next and Back buttons to select other days as desired.

- Press and HOLD buttons to accelerate settings for dates.

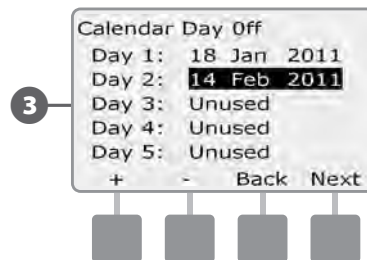

- !** **NOTE:** Calendar Day Off affects ALL programs and stations, including non-irrigation stations. Consider not using this feature if any of your programs include essential functions such as door locks or sports field lighting.

Water Windows

You can specify certain times of the day/night when irrigation is allowed.

Otherwise watering is not allowed outside these “Water Windows”. This is helpful to comply with local regulations which may prohibit irrigation during certain hours.

CAUTION: Be sure a Water Window is sufficient to allow irrigation programs to run completely. Irrigation scheduled outside the Water Window will not run but will resume when the Water Window opens again. This can cause irrigation programs to “stack” and eventually create an alarm condition if the controller stacks 8 or more programs.

NOTE: Water windows can be scheduled to cross midnight. For example, a Water Window can start at 10:00 PM and continue until 4:00 AM the next morning. Be sure your Watering Start Times are set to occur within the Water Window. See Section A, Watering Start Times for more details.

Set Up Water Window

Turn the controller dial to Delay Watering.



- 1 The Delay Watering screen appears. Press the Down Arrow button to select Water Window; then press Next.
- 2 The Water Window screen appears. Press the + and – buttons to set the time when the Watering Window opens; then press Next.
 - Press and HOLD buttons to accelerate settings for hours and minutes.

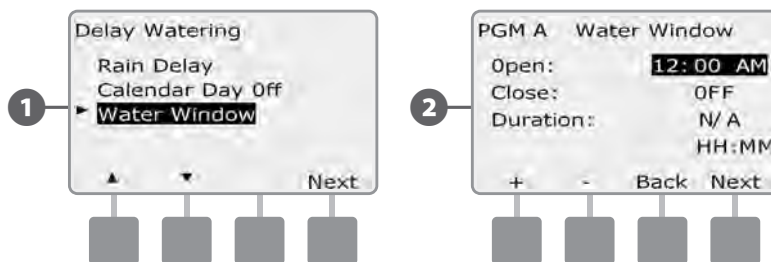

- 3 Press the + and – buttons to set the time when the Watering Window closes. As you adjust the close time, the duration of your Water Window calculates automatically.

NOTE: To clear a previously set Water Window, press the + and – buttons to set both the Open and Close times to OFF (between 11:59 and 12:00 AM).

- 4 To set another program, change the Program Select switch to the desired program; a confirmation appears.

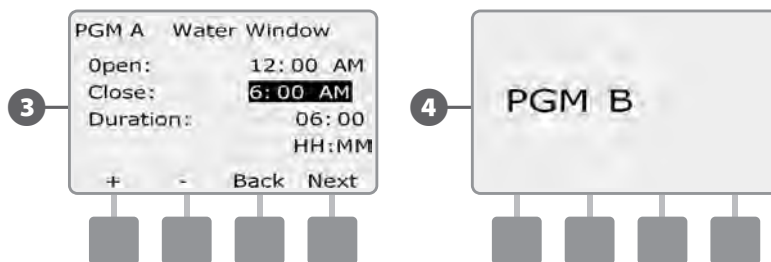

Repeat this process to set or clear Water Windows for other programs as desired.

Watering Cycles

The ESP-LXD controller supports a variety of flexible watering day cycle options.

Watering Cycle Definitions

- ◆ **Custom Days:** irrigation starts every day; but only on days of the week where program starts are allowed.
- ◆ **Odd Dates:** irrigation starts on all odd numbered calendar days, such as the 1st, 3rd, 5th, etc.
- ◆ **Odd Dates no 31st:** irrigation starts on all odd numbered calendar days, such as the 1st, 3rd, 5th, etc., but not on the 31st.
- ◆ **Even Dates:** irrigation starts on all even numbered calendar days, such as the 2nd, 4th, 6th, etc.
- ◆ **Cyclical Dates:** irrigation starts at regular chosen intervals such as every 3rd or 5th day, regardless of the calendar date.



CAUTION: Regardless of the Watering Cycle, irrigation will start only on days of the week where program starts are allowed. See Section B, Select Days to Water for more details. It's important to select allowed irrigation days carefully to avoid landscape damage in case irrigation delays are lengthy.

Custom, Odd, Odd no 31st, Even

The process for setting up Custom, Odd, Odd no 31st, and Even Watering Cycles is very similar.



Turn the controller dial to Watering Cycles.



- 1 The Watering Cycle screen appears. Press the up and Down Arrow buttons to select the desired Watering Cycle; then press Next.



NOTE: If the desired program is not selected, use the Program Select switch to change it. See Section B, Program Select Switch for more details.

- 2 The Program start allowed screen appears. Press the Yes button to allow irrigation to start on a given day or press No to prevent irrigation from starting.

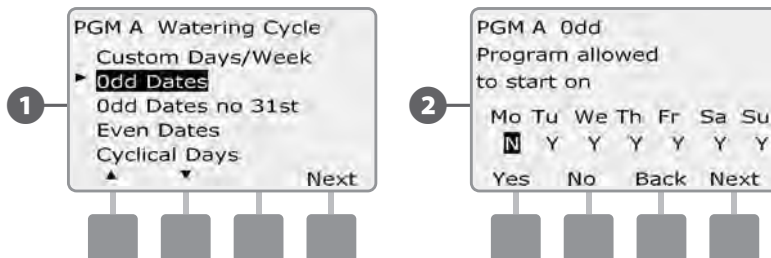

- 3 Press the Next and Back buttons to navigate through the days of the week and repeat the selection process as desired.

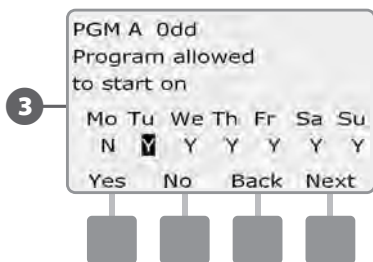

- ↻ Change the Program Select switch and repeat this process to set Watering Cycles for other programs as desired.

- ! **NOTE:** Watering day selections carry over to Watering Days dial positions and vice-versa. See Section B, Select Days to Water for more details.

Cyclical Days

Turn the controller dial to Watering Cycles.



1 The Watering Cycle screen appears. Press the Down Arrow button to select Cyclical Days; then press Next.

NOTE: If the desired program is not selected, use the Program Select switch to change it. See Section B, Program Select Switch for more details.

2 The Day Cycle screen appears. Press the + and – buttons to set the watering day cycle (from 1 to 30 days). For example, set to 03 if you want to water every third day; then press Next.

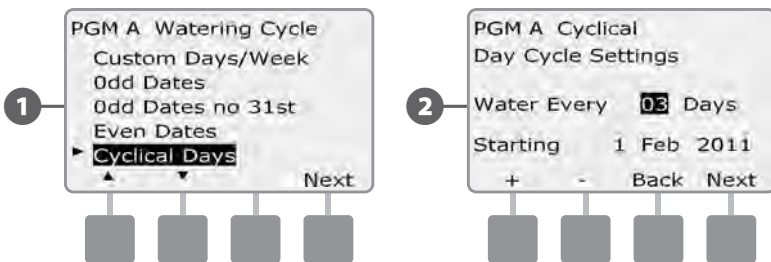

3 Press the + and – buttons to set the first date for the Watering Cycle to begin; then press Next.

- Press and HOLD buttons to accelerate settings for dates.

4 The Watering Day Cycle screen appears. Press the Yes button to allow irrigation to start on a given day of the week or else press No to prevent irrigation from starting.

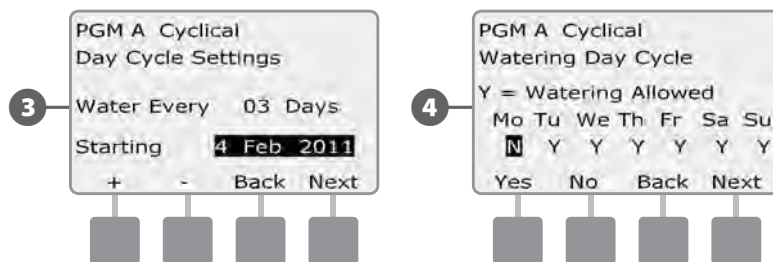

5 Press the Next and Back buttons to navigate through the days of the week and repeat the selection process as desired.

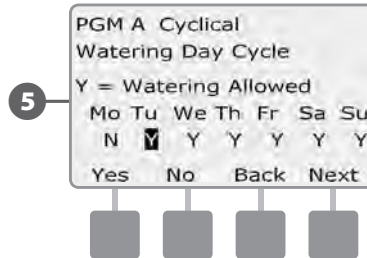

Change the Program Select switch and repeat this process to set Cyclical Watering for other programs as desired.

NOTE: Watering day selections carry over to Watering Days dial positions and vice-versa. See Section B, Select Days to Water for more details.

Station Settings

Set Up Cycle+Soak™

The ESP-LXD controller Cycle+Soak feature allows water to be applied to stations intermittently and without creating complex programs. It can apply to any station and is useful for locations such as hillsides which can be difficult to irrigate effectively.

Cycle+Soak consists of two settings, the cycle time (how long a station will run before soaking) and soak time (how long irrigation is paused before applying another cycle). For example, a station can be set up to receive 15 minutes of irrigation in three 5 minute cycles, with two 10 minutes periods of soak time in between waterings.

NOTE: Cycle+Soak settings apply to stations no matter which programs it may be used in.

Turn the controller dial to Station Settings.



- 1 The Station Settings screen appears with Cycle+Soak selected; press Next.
- 2 The Cycle+Soak screen appears. Press the + and – buttons to enter the desired station number; then press Next.

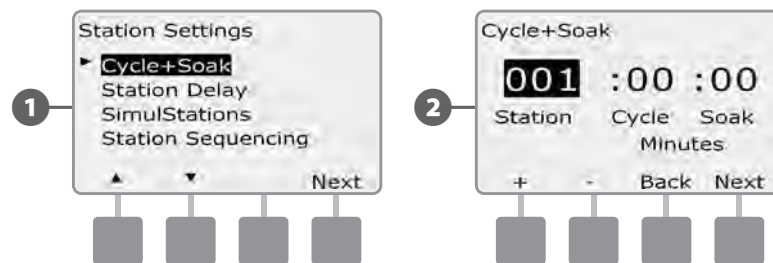

- 3 Press the + and – buttons to set the Cycle time (between 1-60 minutes). Or to cancel Cycle+Soak on that station, set to 0 minutes; then press Next.
 - Press and HOLD buttons to accelerate settings for minutes.
- 4 Press the + and – buttons to set the Soak time (between 1-60 minutes). Or to cancel Cycle+Soak on that station, set to 0 minutes; then press Next.

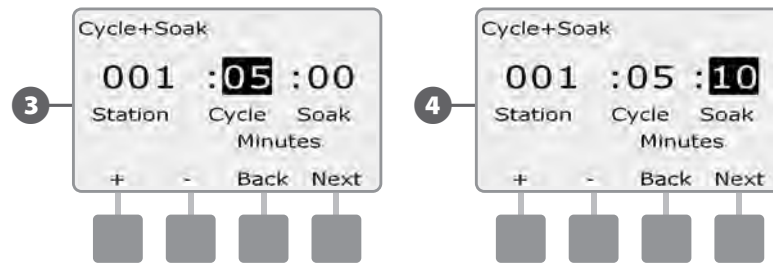

- NOTE:** Consider using short Soak times, particularly if your watering schedule or Water Window is short. Long soak times could prevent irrigation from completing prior to the end of the Water Window. See previous Water Windows for more details.
- NOTE:** The controller is designed to allow additional stations in the irrigation queue to run during the soak time for Cycle+Soak stations.
- Repeat this process to set up Cycle+Soak on other stations.

Set Up Station Delay

The ESP-LXD controller can be programmed to include a delay between stations. This feature delays the start of the next sequential station in a program after the previous station completes.

CAUTION: Consider using short Station Delay times, particularly if your watering schedule or Water Window is short. Long delay times could prevent scheduled irrigation from completing prior to the end of the Water Window. See previous Water Windows for more details.

Turn the controller dial to Station Settings.

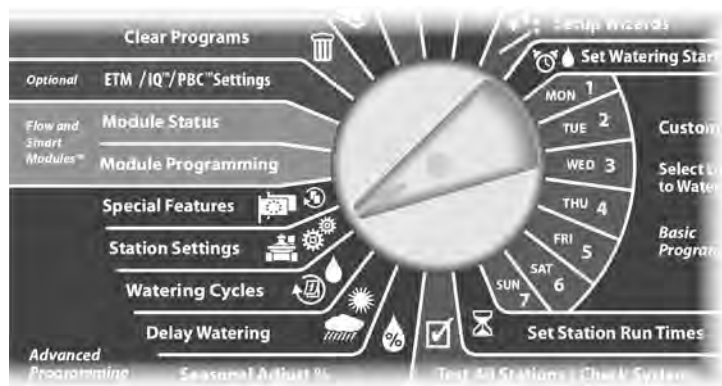

- 1 The Station Settings screen appears. Press the Down Arrow button to select Station Delay; then press Next.
- 2 The Delay Between stations screen appears. Press the + and - buttons to set the delay time (from 00:01 second to 10:00 minutes). Or to clear Station Delay on that station, set to 00:00; then press Next.

- Press and HOLD buttons to accelerate settings for minutes and seconds.

NOTE: If the desired program is not selected, use the Program Select switch to change it. See Section B, Program Select Switch for more details.

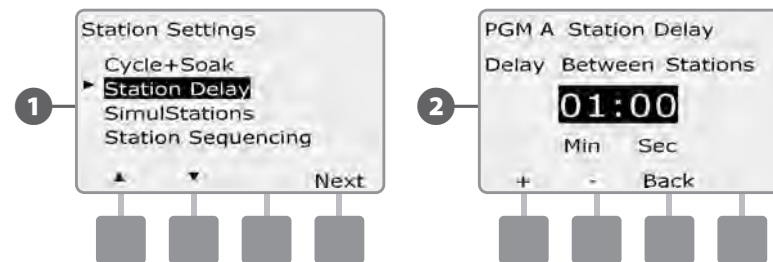

Change the Program Select switch and repeat this process to set Station Delay for other programs as desired.

Set Up SimulStations™

To prevent the ESP-LXD controller from irrigating too many stations simultaneously, you can set the maximum number of stations per program that are allowed to run. This can be beneficial for systems with a small water source and to help ensure uniform water distribution.

CAUTION: The ESP-LXD can run multiple programs and stations concurrently. If all four programs are running two stations, then theoretically 8 stations could be operating at the same time. Many irrigation systems do not have sufficient hydraulic capacity to accommodate such a load. SimulStations can be used to limit the maximum number of stations per program or for the entire controller, but in general we recommend enabling FloManager and setting program-level and LXD-level SimulStations to a fairly high number. This will allow FloManager to provide maximum irrigation based on your system's hydraulic capacity. Consult the FloManager portion of this manual in Section F and Appendix C for additional details.

Set SimulStations™ for Program

Turn the controller dial to Station Settings.



- 1 The Station Settings screen appears. Press the Down Arrow button to select SimulStations; then press Next.
- 2 The Station Settings screen appears with PGM SimulStations selected; press Next.

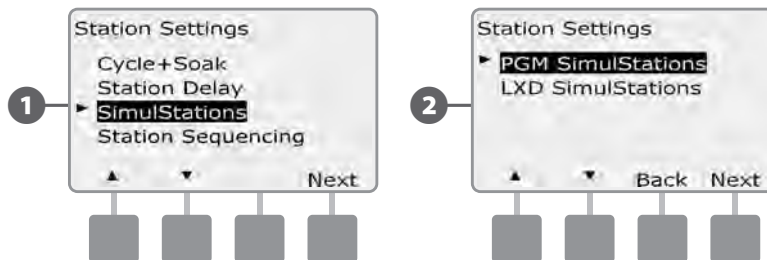

- 3 The Maximum Number of SimulStations screen appears. Press the + and - buttons to set the maximum number of irrigation stations (from 1 to 8) that can operate simultaneously for this program; then press Next.

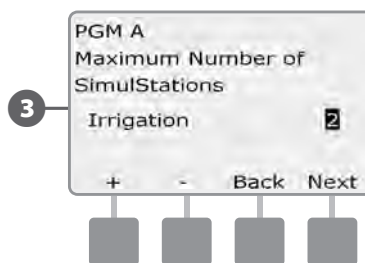

- Change the Program Select switch and repeat this process to set the Maximum Number of Stations for other programs as desired.

Set SimulStations™ for Controller

NOTE: The LXD SimulStations settings will supersede program-level settings. For example, if the LXD setting is 2 but three programs have a maximum setting of 4, then only 2 stations will be allowed to run simultaneously.

Turn the controller dial to Station Settings.

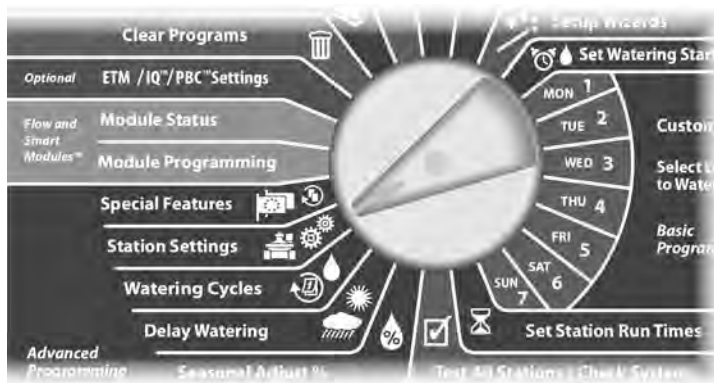

- 1 The Station Settings screen appears. Press the Down Arrow button to select SimulStations; then press Next.
- 2 The Station Settings screen appears. Press the Down Arrow button to select LXD SimulStations selected; then press Next.

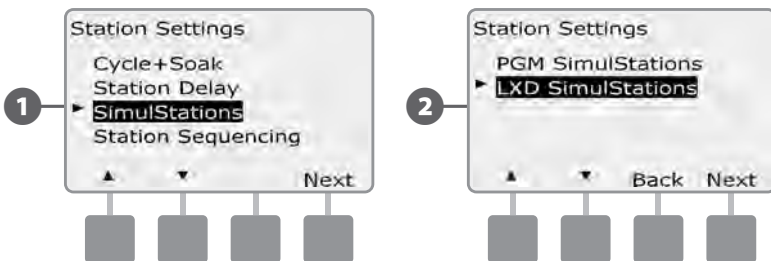

- 3 The ESP-LXD Maximum Number of SimulStations screen appears. Press the + and – buttons to set the maximum number of irrigation stations (from 1 to 8) that can operate simultaneously; then press Next.
- 4 Press the + and – buttons to set the maximum number of non-irrigation stations (from 1 to 4).

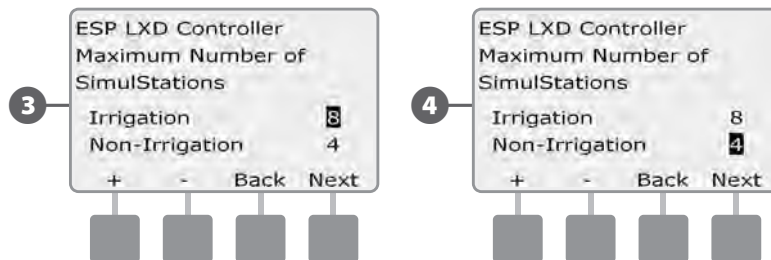

NOTE: The Non-Irrigation SimulStations setting is used to configure the maximum number of Non-Irrigation stations that can operate simultaneously and allows you to balance the number of Irrigation and Non-Irrigation stations that can operate simultaneously. Also note that when SimulStations are set to a maximum of 8, if a Normally Closed Master Valve has to be held open for irrigation to occur, it will limit the maximum number of SimulStations to 7.

Station Sequencing

The ESP-LXD offers advanced programming features to optimize water windows. The Station Sequencing option allows you to select from two methods of station sequencing for program operation:

- Sequence by Station Number (system default).
- Sequence by Station Priority (required when using FloManager). This option decreases the overall time required to complete the program when operating multiple stations simultaneously.

Station Sequencing by Station Numbers will select stations to operate in the following order:

1	Station number	1 > 2 > 3 ...
2	Program assignment	A > B > C > D

! **NOTE:** Non-irrigation priority stations will always be selected to operate first.

Station Sequencing by Station Priority will select stations to operate in the following order:

1	Station priority	Non-Irrigation > High > Medium > Low
2	Station run time	Longest run time > shortest run time
3	Station number	1 > 2 > 3 ...
4	Program assignment	A > B > C > D

! **NOTE:** If FloManager is turned ON, then the default Station Sequencing setting is Sequence by Station Priorities. To select Station Sequencing by Station Number, FloManager must first be turned OFF. See Section F, Flow Management, Enable/Disable FloManager for more details.

▶ Turn the controller dial to Station Settings.

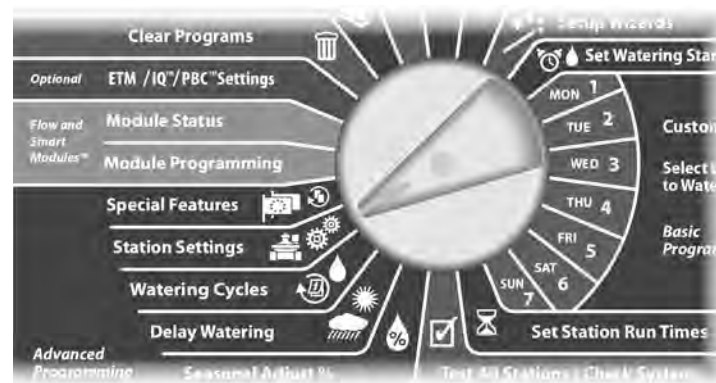

1 The Station Settings screen appears. Press the Down Arrow button to select Station Sequencing; then press Next.

2 The Station Sequencing screen appears. Press the + and - buttons to set Station Sequencing by either Station Numbers or Station Priorities, as desired.

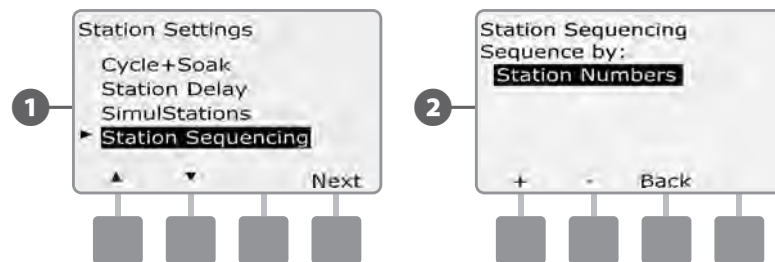

! **NOTE:** When Station Sequencing is set to Sequence by Station Priorities, you can still manually operate stations in station number sequence using the Test All Stations option from the Manual Watering dial position. See Section G, Auxiliary Operation, Manual Watering, Test All Stations for more details.

Section E - Options & Special Features

Backup and Recall Programs

The ESP-LXD controller comes standard with a simple to use backup programs feature.

Backup Programs allows you to save your programs as Contractor Default and then recall them at a later time. It also includes a Delayed Recall feature that lets you save a normal irrigation schedule as the Backup and then restore it later automatically. This may be useful for new seed or sod where frequent irrigation can be programmed to occur until a set date when Delayed Recall automatically returns the controller programming to the normal irrigation schedule.

CAUTION: The Backup Programs feature saves and restores ALL irrigation programming in ALL programs (A, B, C & D).

NOTE: The ESP-LXD also supports eight program backups using the optional Programming Backup Cartridge (PBC-LXD). See Programming Backup Cartridge for more details.

Store Default Programs

Turn the controller dial to Special Features.

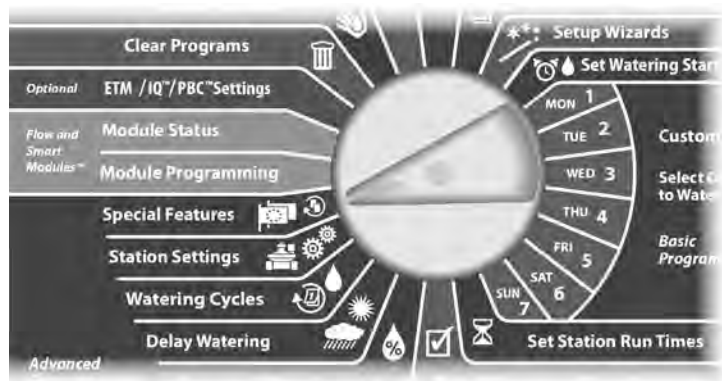

- 1 The Special Features screen appears. Press the Down Arrow button to select Backup Programs; then press Next.
- 2 The Backup Programs screen appears with Store Programs selected; press Next.

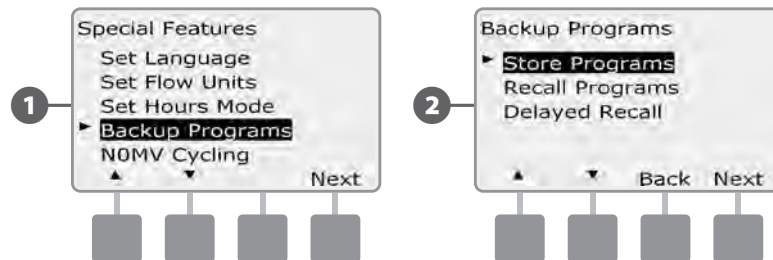

- 3 A confirmation screen appears. To Store Programs, press and hold down the Yes button for four seconds. If you're not sure, press No.
- 4 A confirmation screen appears.

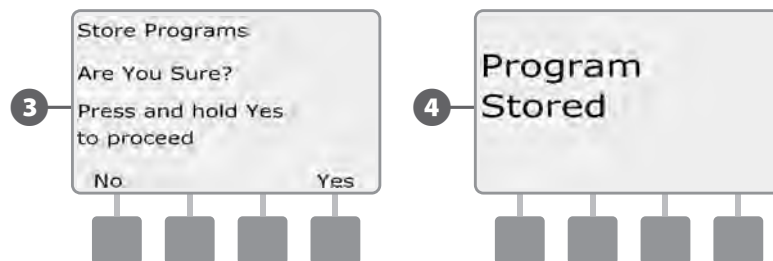

Recall Default Programs

Turn the controller dial to Special Features.



1 The Special Features screen appears. Press the Down Arrow button to select Backup Programs; then press Next.

2 The Backup Programs screen appears. Press the Down Arrow button to select Recall Programs; then press Next.

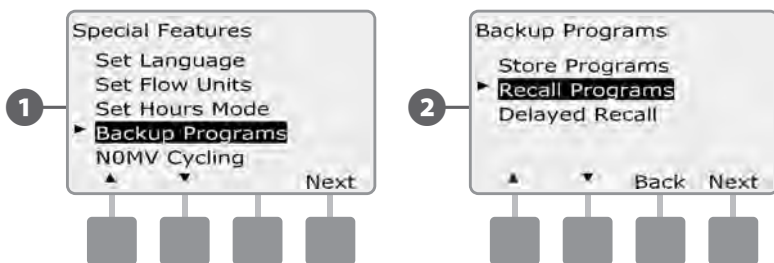

3 A confirmation screen appears. To Recall Programs, press and hold down the Yes button for four seconds. If you're not sure, press No.

4 A confirmation screen appears.

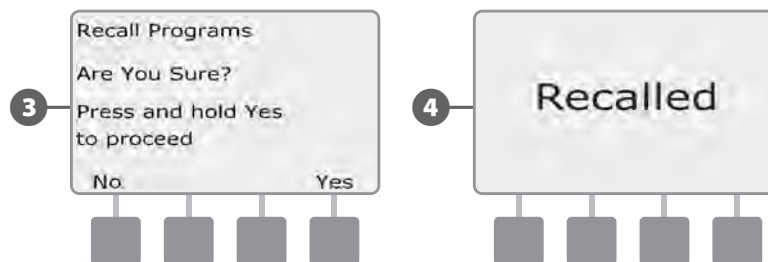

CAUTION: Once current programs have been replaced using Recall Programs they can not be restored.

Delayed Recall

Use the Delayed Recall feature to automatically replace the currently loaded programs with a previously stored program at a future date.

CAUTION: Once current programs have been replaced with the Delayed Recall feature, they can not be restored.

Turn the controller dial to Special Features.



1 The Special Features screen appears. Press the Down Arrow button to select Backup Programs; then press Next.

2 The Backup Programs screen appears. Press the Down Arrow button to select Delayed Recall; then press Next.

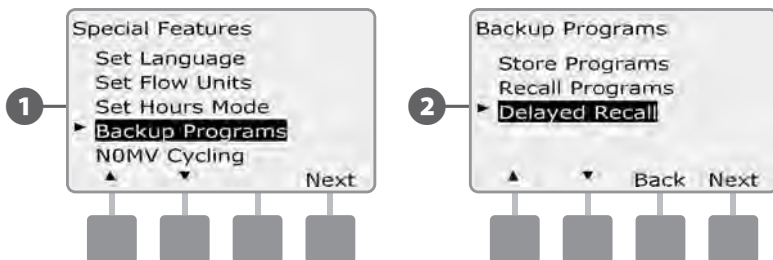

3 The Recall Delay screen appears. Press the + and – buttons to enter the number of days (from 0 to 90 days) before Contractor Defaults are restored. For example, set it to 7 days if you want your original programs to be restored in one week. If you want to clear a previously Delayed Recall, set the number of days to 0.

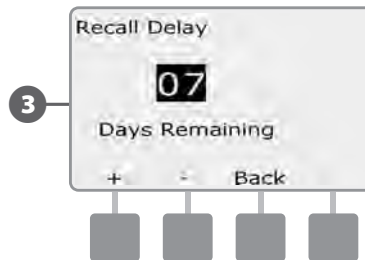

Programming Backup Cartridge (PBC-LXD)

The optional PBC-LXD allows you to manage multiple Backups of irrigation programming.

An optional Programming Backup Cartridge (PBC-LXD) is available for the ESP-LXD controller which allows you to create and Restore multiple Backups of irrigation programs. The PBC-LXD is portable and easy to install and un-install so you can use a single PBC-LXD with multiple ESP-LXD controllers.

PBC-LXD Features

- 1 Reset button - to reset the PBC-LXD.
- 2 Controller Connectivity - illuminates, blinking when the PBC-LXD has connectivity to the controller.
- 3 Barcode Scanning Functionality - illuminates solid when optional barcode scanning pen is connected.



Programming Backup Cartridge (PBC-LXD)

Barcode Scanning Feature

With a PBC-LXD cartridge installed, you can also set up Field Decoder addresses using an optional barcode scanning feature.

The PBC-LXD unit ships complete with an accessory PBC-LXD RJ45 Connector Cable for use with a barcode scanning pen. If you do not plan to use the barcode scanning feature right away then store the cable away for possible use at a later date.

If you do plan to use a barcode scanning pen then follow the additional instructions to attach it to the PBC-LXD before closing the cartridge bay (see Install Barcode Scanning Pen for more details).



PBC-LXD RJ45 Connector Cable

! **NOTE:** It's not necessary to install the barcode pen feature in order to use the PBC-LXD Backup and Restore functions.

Installing a PBC-LXD

The Programming Backup Cartridge (PBC-LXD) gets installed in the back of the controller front panel.

- 1 Open the controller outer cabinet door and inner front panel. See Section H, Access Controller Cabinet for more details.
- 2 Press down on the top-latch of the cartridge bay cover and remove it from the back of the controller front panel.

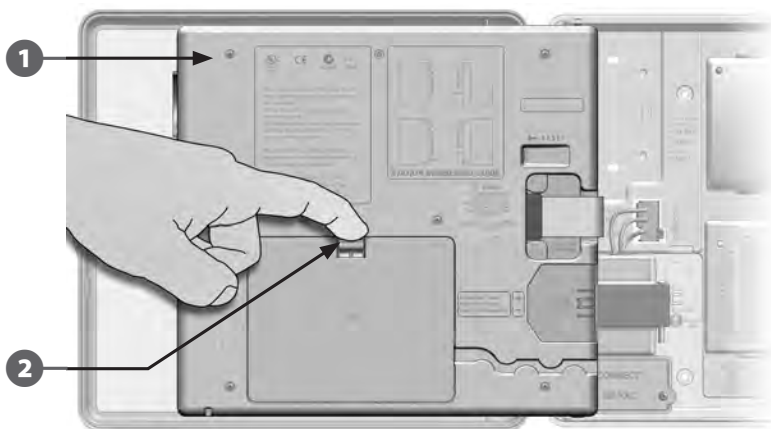

- 3 Connect the PBC-LXD ribbon cable to the knife-edge connector located at the top-left corner inside the cartridge bay of the controller front panel.

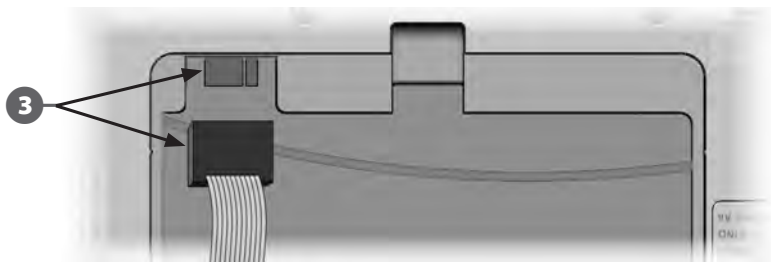

- 4 Orient the cartridge so that the two bottom hinges fit into the hinge openings at the bottom of the cartridge bay. Then gently swing the PBC-LXD up into place, snapping the top-latch.

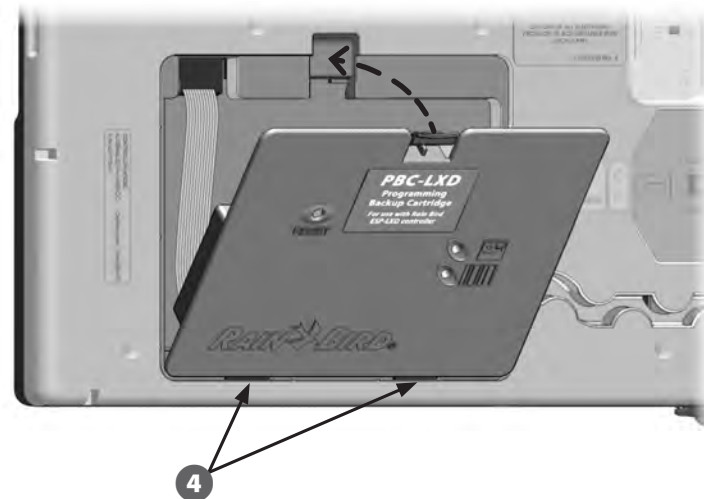

- Turn the controller dial to ETM/IQ/PBC Settings to check that the controller has recognized the PBC-LXD.

! **NOTE:** There may be a short delay while the ESP-LXD controller recognizes the newly installed cartridge for the first time.

! **NOTE:** The PBC-LXD can be operated only in a controller connected to power. It can not be operated in front panels powered only by a 9 volt battery.

Backup Programs to PBC-LXD

Follow this procedure to backup irrigation programs.

- 1 Turn the controller dial to ETM/IQ/PBC Settings.



- 2 The PBC Main Menu appears with Backup selected; press Next.
- 3 The PBC Backup screen appears. Press the + or – buttons to choose a Backup file; then press Next.

NOTE: 8 different Backup files are available, with names that are assigned automatically (Backup01 through Backup08). The names cannot be changed but the date and time stamp update automatically whenever a particular file is used. Unused files display as <Unused>.

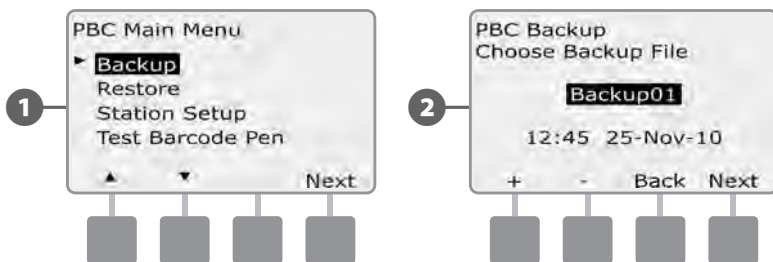

- 4 A confirmation screen appears showing that Backup is in progress.

CAUTION: If you select a previously used Backup file as the destination, that file will be overwritten and cannot be recovered.

- 5 A second confirmation screen appears when Backup is complete.

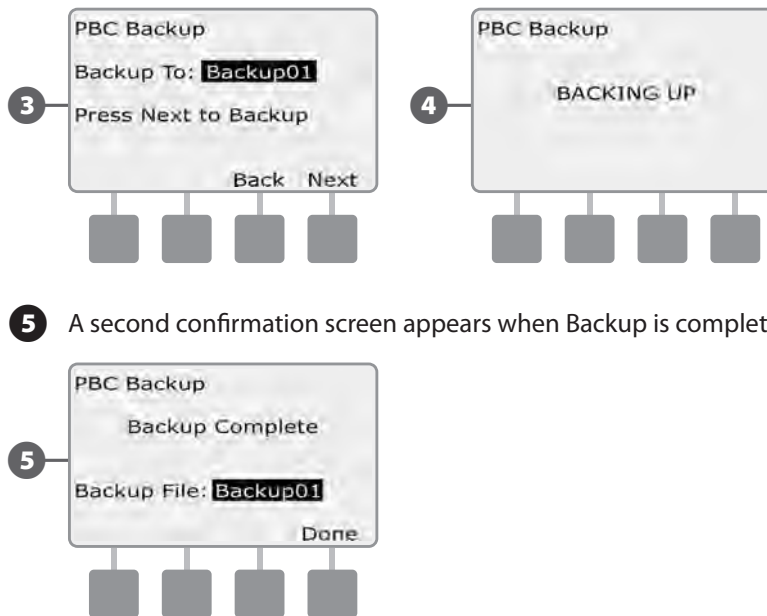

Restore Programs from PBC-LXD

Follow this procedure to Restore irrigation programs from a previous Backup.

CAUTION: Restore deletes all current programs and replaces them with stored programs from the selected Backup file. It's recommended to create a temporary Backup of current programs before using Restore.

Turn the controller dial to ETM/IQ/PBC Settings.



1 The PBC Main Menu appears. Press the Down Arrow button to select Restore Programs; then press Next.

2 The PBC Restore screen appears. Press the + or - buttons to choose a Restore file; then press Next.

NOTE: Available files display a creation date and time stamp. Unused files display as <Unused> and are not available for Restore.

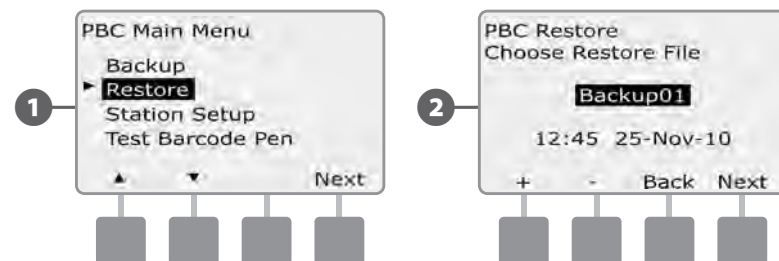

3 A confirmation screen appears, showing the Backup file selected for Restore. Press Next to begin Restore.

4 A confirmation screen appears showing that Restore is in progress.

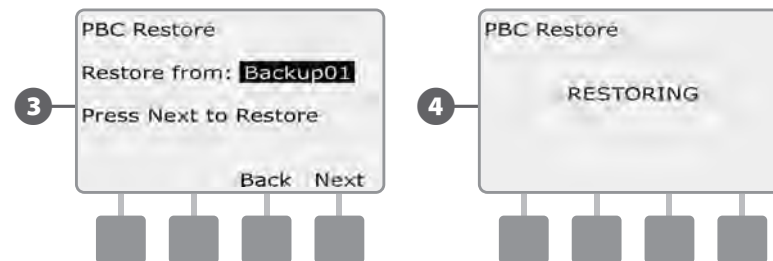

5 A second confirmation screen appears when Restore is complete.

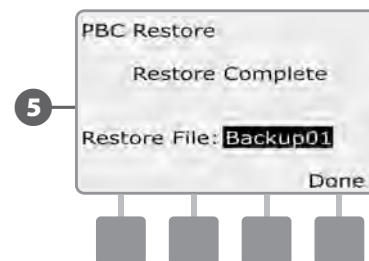

Decoder Barcode Scanning

The optional Decoder Barcode Scanning feature allows you to automatically enter Field Decoder Addresses into the ESP-LXD controller.

Decoder barcode scanning is an optional feature of the Programming Backup Cartridge (PBC-LXD) that lets you set up Field Decoder addresses in the ESP-LXD controller by using a barcode scanning pen to read the removable barcode labels attached to Rain Bird's field decoders (see Programming Guide instructions for more details).

! **NOTE:** The optional barcode scanning pen must be purchased separately. Rain Bird recommends using a Unitech MS100-2 barcode pen with 9 pin (female) serial connector. Go to www.ute.com for more details.

Install Barcode Scanning Pen

For this installation, you will need the following:

Programming Backup Cartridge (PBC-LXD)



Barcode Scanning Pen (Unitech MS100-2 recommended)



PBC-LXD RJ45 Connector Cable (Included with PBC-LXD)



Barcode Scanning Pen Installation Components

- 1 Open the controller outer cabinet door and inner front panel. See Section H, Access Controller Cabinet for more details.
- 2 Press down on the top-latch of the cartridge bay cover (or PBC if already connected) and remove it from the back of the controller front panel.

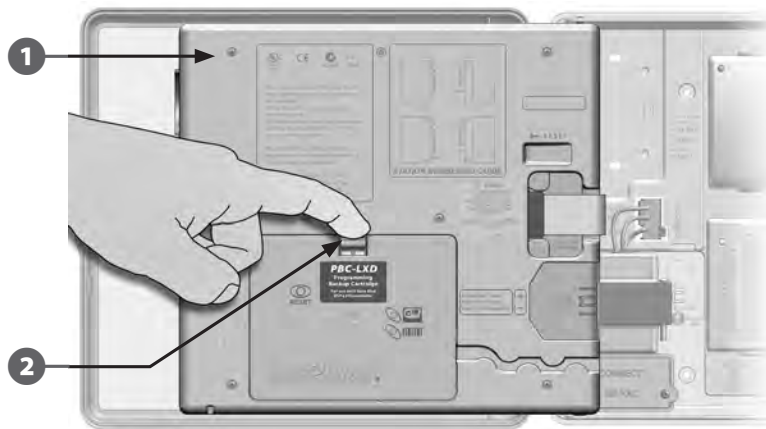

- 3 Plug the PBC-LXD RJ45 Connector Cable into the connection jack on the back-side of the PBC-LXD.

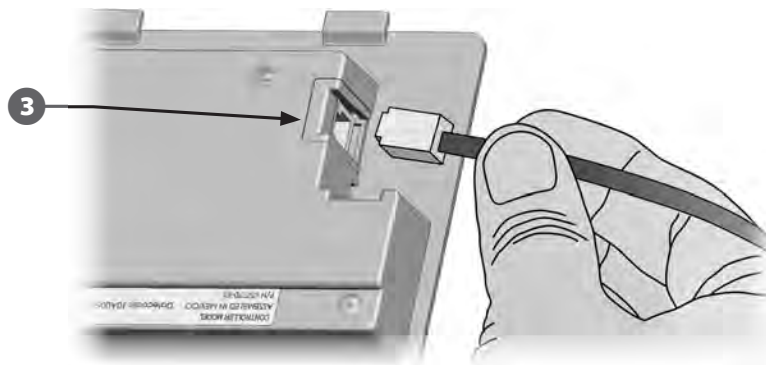

- 4** Ensure the PBC-LXD ribbon cable is connected to the knife-edge connector located at the top-left corner inside the cartridge bay of the controller front panel.

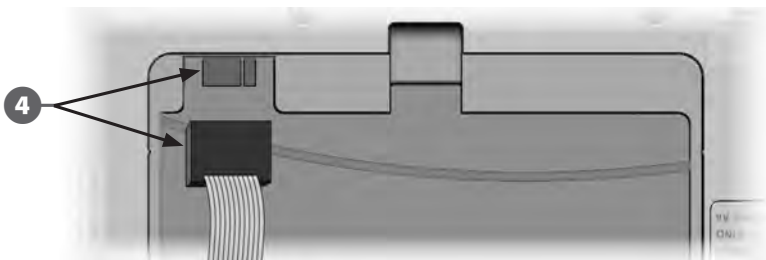

- 5** Orient the PBC-LXD so that the two bottom hinges fit into the hinge openings at the bottom of the cartridge bay. Then gently swing the PBC-LXD up into place, snapping the top-latch.

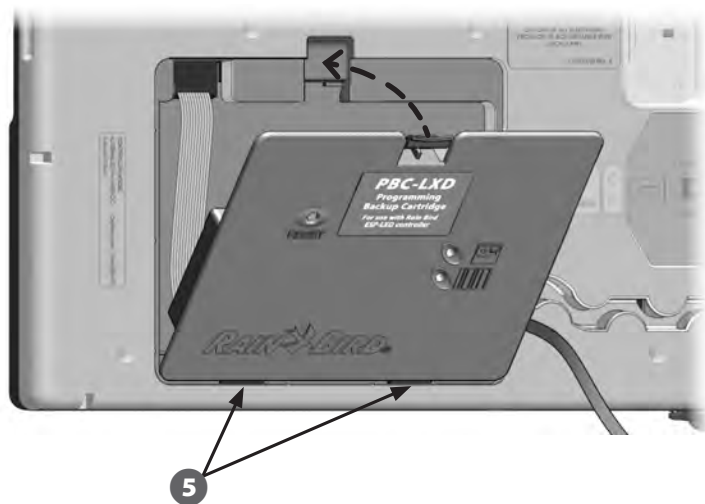

- 6** Route the PBC-LXD RJ45 Connector Cable through the cable channel on the back of the controller front panel.

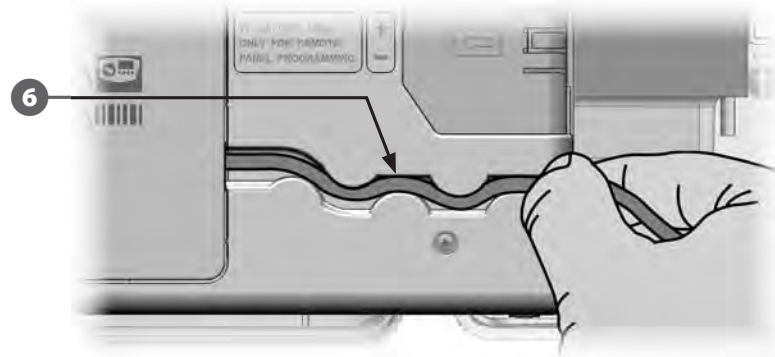

- 7** Attach the Barcode Scanning Pen cable's serial connector (9 pin female) to the PBC-LXD Connector cable's serial connector (9 pin male).

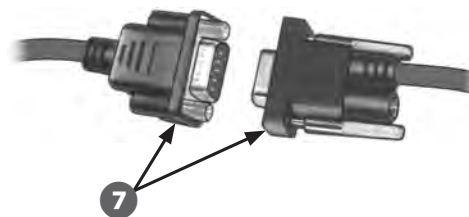

Set Up Barcode Scanning Pen

The barcode scanning pen requires initial setup before using.

! **NOTE:** The optional barcode scanning pen must be purchased separately. Rain Bird recommends using a Unitech MS100-2 barcode pen with 9 pin (female) serial connector. Go to www.ute.com for more details.

- 1 Locate the Programming Guide that came with the ESP-LXD controller.



- 2 On page 26 of the Programming Guide, under Barcode Scanning Pen Setup, locate Setup Barcode #1. Scan the barcode lengthwise as shown. You'll hear audible beep(s) to confirm that the first scan was successful.

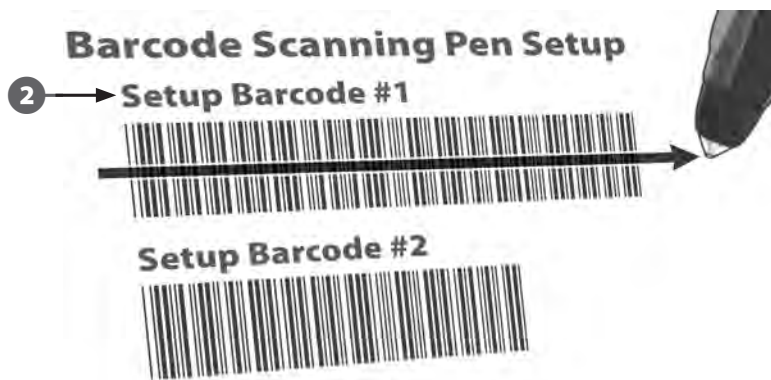

- 3 Then scan Setup Barcode # 2 and again you'll hear audible beep(s) to confirm that the second scan was successful. The barcode scanning pen is now ready for use.

! **NOTE:** If you do not hear audible beep(s) to confirm scan success then repeat the process until you hear the beeps.

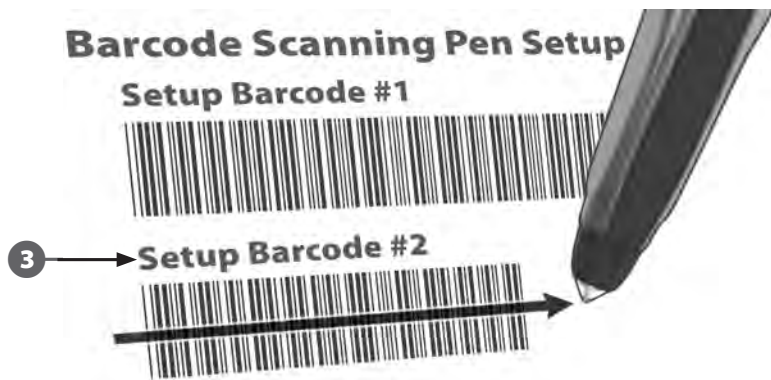

Test Barcode Scanning Pen

- 1 Locate the Programming Guide that came with the ESP-LXD controller.



- 2 Turn the controller dial to ETM/IQ/PBC Settings.



- 2 The PBC Main Menu appears. Press the Down Arrow button to select Test Barcode Pen; then press Next.

- 3 The PBC Test Barcode Pen screen appears with instructions.

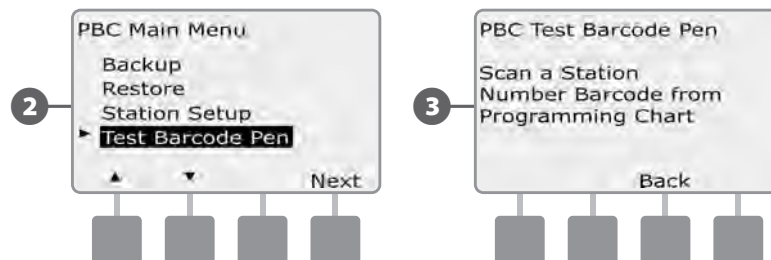

- 4 Scan any station Number Barcode (as shown on pages 6-25 of the Programming Guide). You'll hear an audible beep to confirm when the scan was successful.

- 5 The Success! screen will appear and the station # field will display the station number of the scanned barcode.

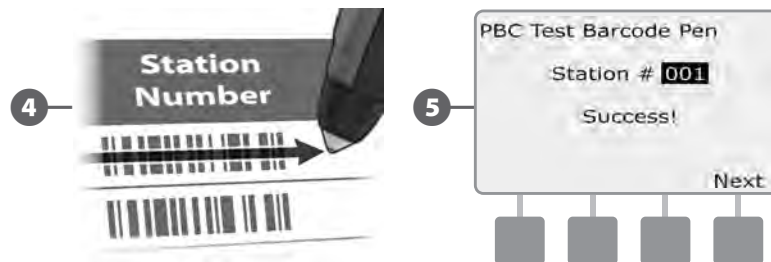

- NOTE:** Return the Programming Guide to a permanent, safe location when you're finished working with it. We recommend hanging it on the hook inside the controller cabinet door.

Scan Field Decoder Addresses

Set up field decoders automatically by scanning.

CAUTION: Barcode scanning replaces any previous decoder addresses stored in the controller. Be sure to complete the previous Test Barcode Scanning Pen process before starting as the test process will not update or replace your decoder addresses.

- 1 Locate the Programming Guide that came with the ESP-LXD controller.



- 2 Ensure that the station Decoder Address Labels are affixed in the proper locations on the Programming Guide (see Programming Guide instructions for more details).

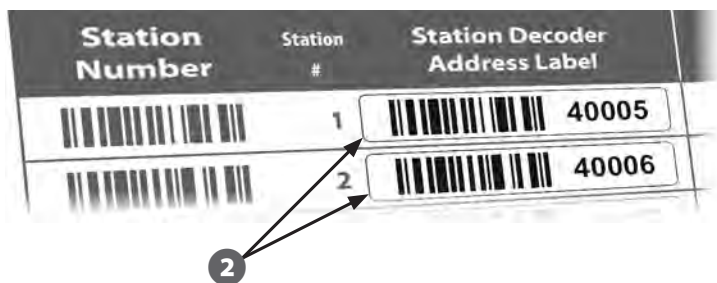

- Turn the controller dial to ETM/IQ/PBC Settings.



- 3 The PBC Main Menu appears. Press the Down Arrow button to select station Setup; then press Next.
- 4 The PBC station Setup (Scan When Ready) screen appears.

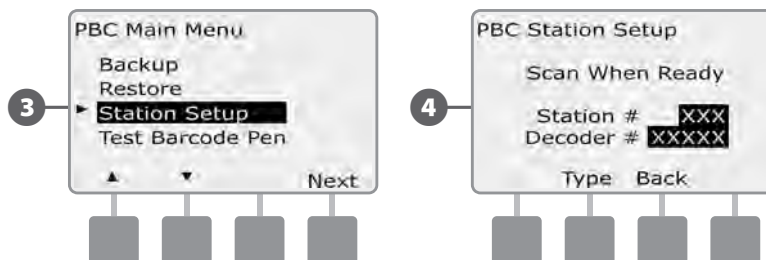

- 5 On the Programming Guide, scan a station Number barcode and corresponding station Decoder Address Label in sequence. You'll hear audible beep(s) to confirm when scans are successful.



- 6 The Successful Scan screen appears and the station # and Decoder # fields will be updated with the scanned barcode data (the screen will always display the most recently scanned data).

Press the Save button to store the scanned station Number and station Decoder Address in the controller. Or else press Cancel to go back or retry scanning again.

- !** **NOTE:** It's not necessary to scan Field Decoder addresses sequentially. Station, Sensor or MV addresses can be scanned in any numeric order. For example, you could scan station 2 before scanning station 1, if necessary.

- 7 To scan master valve, flow sensor or weather sensor decoders; from the Scan When Ready screen, press the Type button to select the desired device. Then repeat the scanning process as previously described.

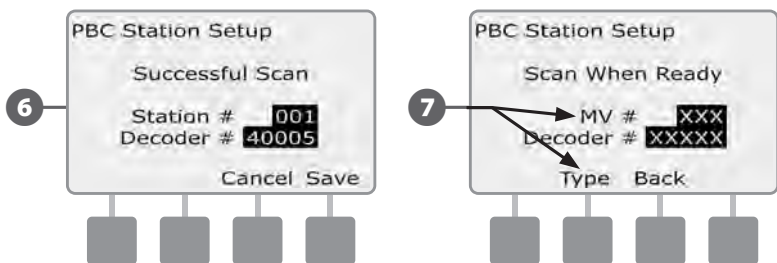

- !** **NOTE:** If either barcode does not scan on the first attempt, try scanning one or both barcodes again until you hear the beep(s) and until the screen has updated to show both the station (or Sensor or MV) Number and the Decoder Address. If scanning problems persist, you can still enter decoder addresses manually. See Section B, Setup Wizards for more details.

- ↻** Repeat this process and continue to scan and set up additional Field Decoder addresses as desired.

- !** **NOTE:** Even if you don't plan to use a barcode scanning pen, we recommend carefully removing the peel-off barcodes from your field decoders and affixing them to the proper positions in the Programming Guide (see the Programming Guide instructions for more details).

Special Features

Set Language

You can set the ESP-LXD controller to one of six supported languages; English, Spanish, French, Portuguese, Italian or German. Changes to the default language affect all screens and menus.

▶ Turn the controller dial to Special Features.

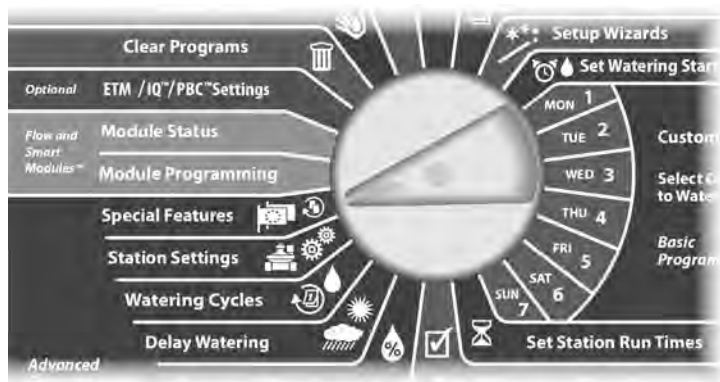

1 The Special Features screen appears with Set Language selected; press Next.

! **NOTE:** If the controller is set to a language you do not speak, Set Language is the top item on the Special Features main menu.

2 The Set Language screen appears. Press the + and - buttons to select the desired language.

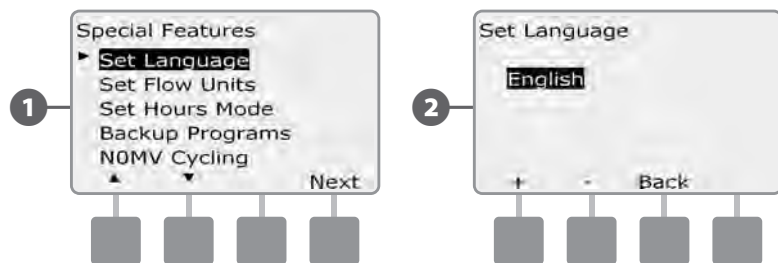

Set Hours Mode

You can set the ESP-LXD controller to display time in one of three hours modes; Auto, AM/PM or 24 Hour.

▶ Turn the controller dial to Special Features.



1 The Special Features screen appears with Set Language selected. Press the Down Arrow button to select Set Hours Mode; then press Next.

2 The Set Hours Mode screen appears. Press the + and - buttons to select the desired hours mode.



! **NOTE:** Auto defaults to AM/PM when 60 Hz power is detected and to 24 Hour mode when 50 Hz power is detected.

NOMV Cycling

Since Normally Open Master Valves (NOMVs) are always open, it's sometimes helpful to cycle them closed for a minute in order to maintain the continuity of your valve diaphragms and solenoids. The controller can be programmed to perform this task automatically.

NOTE: Each NOMV will be cycled closed for 60 seconds on the first day of each month. Since irrigation is suspended when the NOMV is shut, choose a time when irrigation is not scheduled for this operation.

Turn the controller dial to Special Features.



1 The Special Features screen appears. Press the Down Arrow button to select NOMV Cycling; then press Next.

2 A confirmation screen appears; press Next when ready.

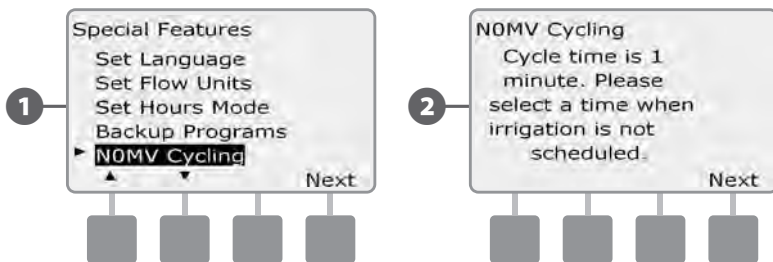

3 The NOMV Cycling screen appears. Press the + and – buttons to set the desired time for cycling to start; then press Next.

- Press and HOLD buttons to accelerate settings for hours and minutes.

4 Press the Yes button to allow cycling to start for each MV or press No to prevent cycling from starting; then press Next.

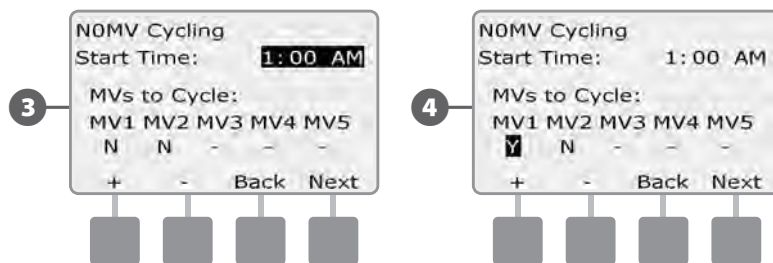

5 Press the Next and Back buttons to navigate through the MVs and repeat the selection process as desired.

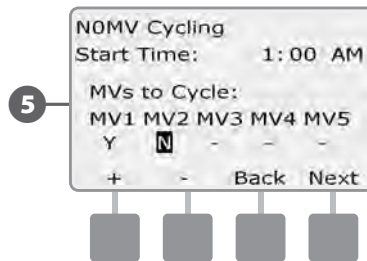

NOTE: There is no need to cycle Normally Closed Master Valves (NCMV) open, so they are not included in the selection screen. NCMVs will show as - and can not be changed.

Once you advance past the last MV, you will be returned to the Special Features screen.

this page intentionally left blank

Section F - Flow Management

The ESP-LXD controller offers a wide variety of flow-related functionality to utilize your system more efficiently, with or without additional flow sensing hardware.

Introduction to Flow

FloZones™ Overview

To optimize the controller's flow features, it's important to first understand FloZones. A FloZone is a collection of one or more stations all using the same water source. In a simple irrigation system such as a private residence, water is often supplied from a single source (typically from the local municipality) and in that case all stations are part of a single FloZone.

In a typical commercial installation, each FloZone will have its water source(s) controlled by individual Master Valve(s) (or MVs). For this reason, the number of FloZones is often the same as the number of MVs. The number of FloZones can never be greater than the number of water sources and if multiple water sources (and likely MVs) supply the same section, then the number of FloZones will be less than the number of MVs.

It's important to fully understand your system's hydraulic properties to set up your water sources, MVs and FloZones appropriately. For more information on setting up MVs and FloZones. See Section B, Master Valves Setup for more details.

ESP-LXD Flow Management Features

After understanding and correctly setting up the MVs and FloZones for your system, the next step is to decide which flow-related features you'd like to use.

The ESP-LXD controller flow features can be divided into two different functional groups; FloManager and FloWatch.

FloManager™ Overview

FloManager adds basic hydraulic management features to your system to ensure that sufficient water pressure and volume is available to operate all stations. Although it is helpful, flow sensing hardware is not required to use FloManager. You can manually enter estimated flow rates even if flow sensing hardware is not installed.

FloWatch™ Overview

FloWatch allows you to use any or all of the FloManager features but adds additional functionality such as alarms for high flow (SEEF) and low flow (SELF) situations based on parameters you set and control. See SEEF and SELF Settings and Actions for more details.

 **NOTE:** Flow sensing hardware is required to use FloWatch.

Set Flow Units

To use FloManager or FloWatch with the ESP-LXD controller, you first need to set the measurement units for flow management.

▶ Turn the controller dial to Special Features.



3 Press the + and - buttons to select the desired pipe size measurement (English or metric).

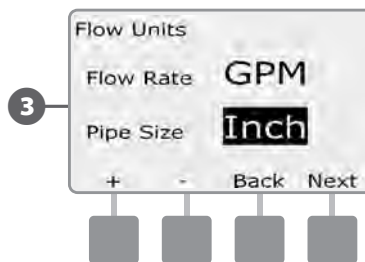

! **NOTE:** If Auto is selected, Flow Rate will default to GPM when 60 Hz is detected and to LPS when 50 Hz is detected. Pipe Size will default to Inches on 60 Hz and to millimeters on 50 Hz.

1 The Special Features screen appears. Press the Down Arrow button to select Set Flow Units; then press Next.

2 The Flow Units screen appears. Press the + and - buttons to select the desired flow measurement (English or metric); then press Next.

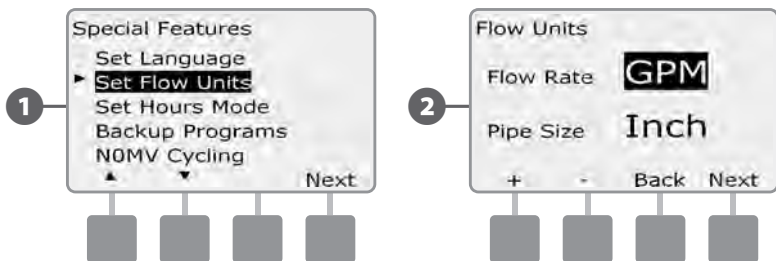

FloManager™

One of the most powerful flow management features in the ESP-LXD controller is FloManager, which enables the controller to allocate available water pressure and volume to various stations based on their hydraulic requirements. This can be done even if flow sensors are not present.

FloManager works by adding another layer of station or FloZone prioritization based on available water resources. For example, if FloZone 1 has 20 GPM available flow and two stations each consuming 6 GPM are currently in operation for a total of 12 GPM, FloManager will not allow an additional station to start unless it consumes 8 GPM or less. This helps ensure that your system's hydraulic resources are not overtaxed and that sufficient water is available to every sprinkler in every station.

Set Up and Use FloManager™

If you have not already done so, use the Setup Wizards to set up all master valves and their FloZones. It's not necessary to install or set up flow sensors to use FloManager, but if you do have this hardware present it's usually helpful to set it up prior to activating FloManager. See Section B, Flow Sensors Setup for more details.

Once FloManager has been activated we recommend that you Learn Flow or manually enter flow rates for all stations and FloZones. This will allow FloManager to dynamically allocate water resources. If you do not have flow sensing hardware installed you may be able to estimate flow rates based on the irrigation hardware installed on a particular station or FloZone and manually enter this rate.

Enable (Or Disable) FloManager™

 Turn the controller dial to Module Programming.



- 1 The Smart Module PGM screen appears with Flow Smart Module selected; press Next.
- 2 The Flow Smart Module PGM screen appears. Use the Down Arrow to select FloManager; then press Next.

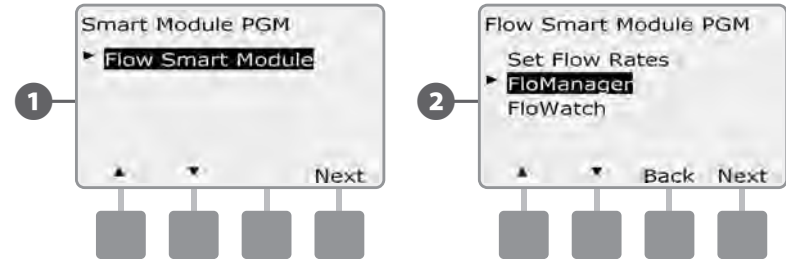

- 3 Press the On button to enable FloManager, or press Off to disable.
- 4 If Station Sequencing was previously set to Station Numbers, then turning FloManager ON will automatically change the setting to Station Priorities. Press Accept to make the change or else press Reject. See Section D, Advanced Programming, Station Sequencing for more details.

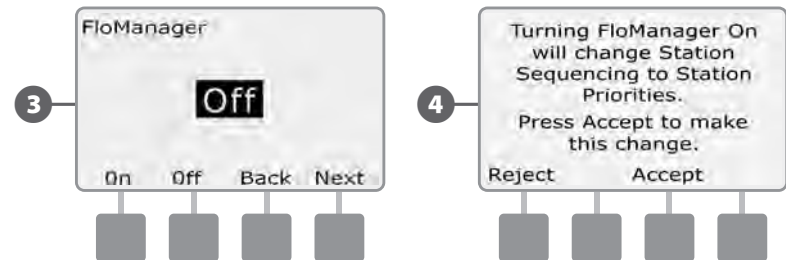

Set Flow Rates Manually

Allowing the controller to Learn Flow automatically is the easiest, most accurate method to enter flow readings. However, you can manually enter flow rates for one or more stations or flow zones before or after an automatic Learn Flow exercise.

Set Station Rates

Turn the controller dial to Module Programming.

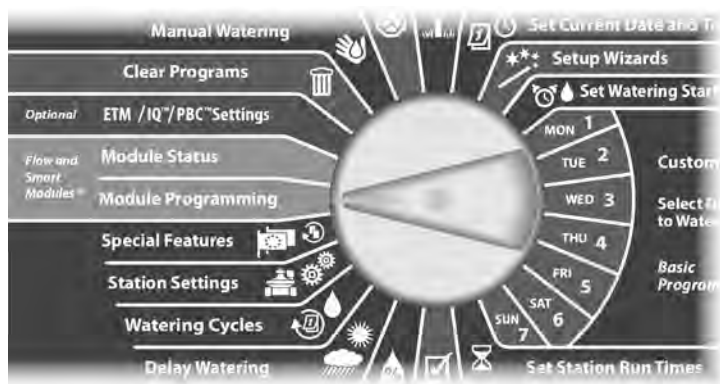

- 1 The Smart Module PGM screen appears with Flow Smart Module selected; press Next.
- 2 The Flow Smart Module PGM screen appears with Set Flow Rates selected; press Next.

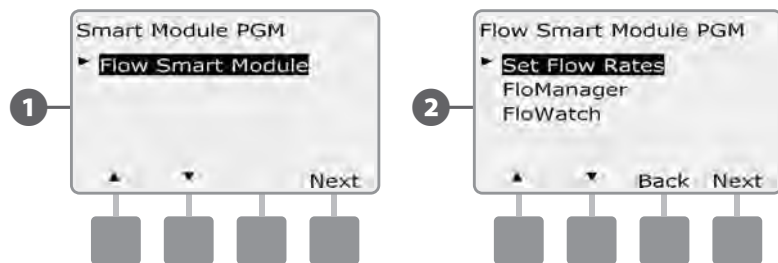

- 3 The Set Flow Rates screen appears. Press the Down Arrow button to select Set Station Rates; then press Next.
- 4 Press + and - (buttons 1 and 2) to select the desired station number; then press - (button 4).

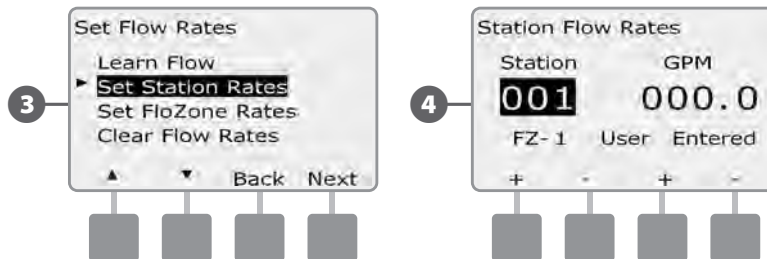

- 5 Press + and - (buttons 3 and 4) to enter the desired Flow Rate for that station. Press - (buttons 2 and 4) to navigate between the station and flow rate fields.
 - Press and HOLD buttons to accelerate settings for GPM.

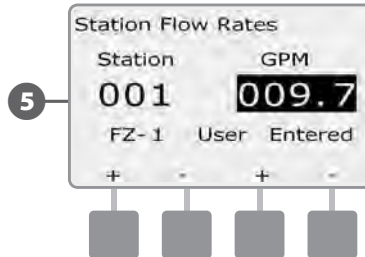

- Repeat this process to manually set up Flow Rates for additional stations as desired.

Set FloZone™ Rates

➤ Turn the controller dial to Module Programming.



- 1 The Smart Module PGM screen appears with Flow Smart Module selected; press Next.
- 2 The Flow Smart Module PGM screen appears with Set Flow Rates selected; press Next.

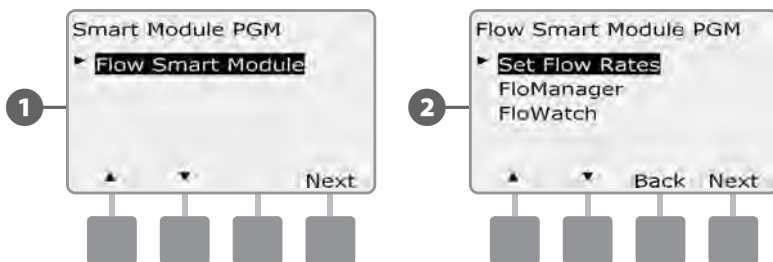

- 3 The Set Flow Rates screen appears. Press the Down Arrow button to select Set FloZone Rates; then press Next.
- 4 The FloZone Flow Rates screen appears. Press + and - (buttons 1 and 2) to select the desired FloZone number; then press - (button 4).

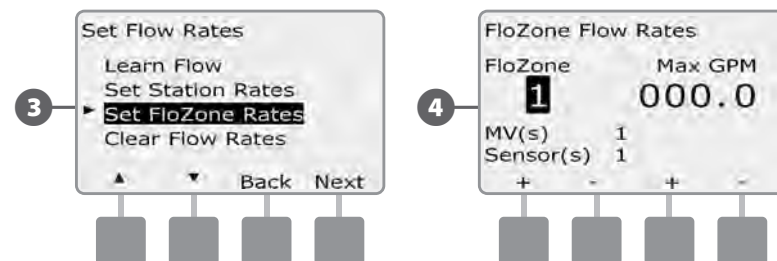

- 5 Press + and - (buttons 3 and 4) to enter the desired Flow Rate for that FloZone. Press - (buttons 2 and 4) to navigate between the FloZone and Flow Rate fields.

- Press and HOLD buttons to accelerate settings for GPM.

! **NOTE:** Maximum FloZone flow rates are used only by FloManager. FloWatch is unaffected by user-entered FloZone flow rates.

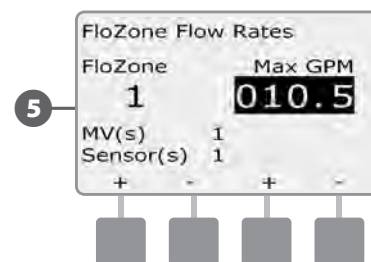

↻ Repeat this process to manually set up Flow Rates for additional FloZones as desired.

After FloManager is enabled and station and/or FloZone flow rates are entered, FloManager works automatically in the background to run stations based on available hydraulic capacity

! **NOTE:** FloManager can be used with or without flow sensing hardware. If flow sensors are not present it will rely on manually entered information; if flow sensors are present it will rely on Learned Flow information, which is typically more accurate.

FloWatch™

FloWatch unleashes the true power of the ESP-LXD controller. FloWatch compares current flow conditions to expected learned or user-entered flow rates and takes various actions based on your settings and input. Since current flow conditions are required, FloWatch can only be used when flow sensors are present. To use FloWatch, you must do all of the following:

- A.** Install flow monitoring hardware into the appropriate locations of your irrigation system. You should install one flow sensor just downstream of each master valve but upstream of any valves. To ensure stable readings, flow sensors should be installed at least ten times the distance of the pipe diameter downstream of the Master Valve with an additional five pipe diameter distance between the flow sensor and any additional hardware.
- B.** Connect each flow meter to an SD-210 sensor decoder using the instructions in the “Connecting Decoders” portion of the Installation section of this manual.
- C.** Set up the flow sensors using the flow sensor setup wizard described in the Setup Wizards portion of the Basic Programming section of this manual.
- D.** Follow the directions below to set up FloWatch.

 **NOTE:** Once you have set up flow on your controller, the current flow rate will be displayed on the Auto screen unless you turn off FloWatch. For more information on turning FloWatch on and off, see “Setting Up and Using flow” below.

Set Up and Use FloWatch™

The ESP-LXD controller lets you set the flow rates you expect or to automatically Learn Flow rates based on real usage. Once flow is learned or manually entered, the SEEF and SELF settings let you define the parameters for excessive or low flow and to set the behavior of the controller when these conditions are detected. You can also turn FloWatch off or back on again if you like.

FloWatch needs expected flow rates to work properly. Flow rates can be entered manually or can be learned automatically through a Learn Flow process. An automatic Learn Flow operation will Learn Flow for each station that has programmed run times. Ensure you have set up runtimes for all stations included in a Learn Flow exercise prior to setting up a Learn Flow.

A FloZone is a group of stations downstream of a master valve and flow sensor. In a shared main line, stations may be downstream of more than one master valve and flow sensor. Since LXD supports up to 5 Master Valves, as many as 5 FloZones can be created. An irrigation system consisting of 5 MVs flowing into 5 individual main lines would result in 5 FloZones. An irrigation system consisting of 5 Master Valves flowing into one shared main line would result in 1 FloZone.

 **NOTE:** Prior to learning or manually setting flow, it is a good idea to check the master valve assignments for each of your stations. See the “station Setup” portion of the Setup Wizards portion of this manual in Basic Programming.

 **NOTE:** Water pressure, particularly from municipal sources, can vary significantly throughout the day. To mitigate this variance, use the time delay option to delay the Learn Flow start time to when irrigation would normally operate.

Enable (or Disable) FloWatch™

- Turn the controller dial to Module Programming.



- 1 The Smart Module PGM screen appears with Flow Smart Module selected; press Next.
- 2 The Flow Smart Module PGM screen appears. Use the Down Arrow to select FloWatch; then press Next.

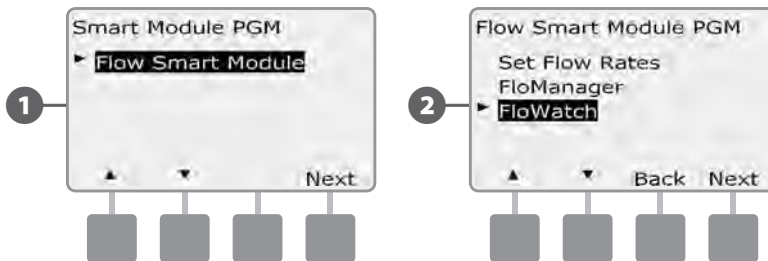

- 3 The FloWatch screen appears. Use the Down Arrow to select FloWatch On/Off; then press Next.
- 4 Press the On button to enable FloWatch, or else press Off to disable.

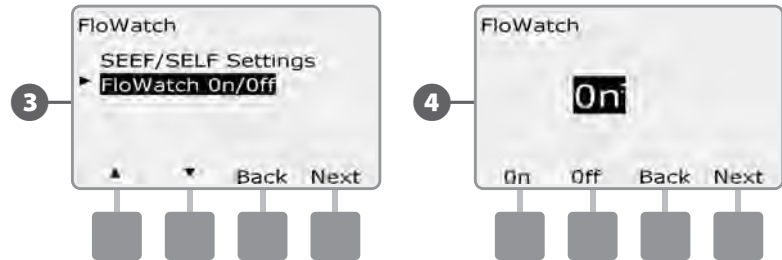

- !** **NOTE:** Once FloWatch is enabled we recommend that you Learn Flow or manually enter flow for all stations and FloZones if you have not already done so. This will allow FloWatch to react appropriately to the SEEF and SELF settings.

SEEF and SELF Settings and Actions

To most effectively use FloWatch, you will want to first set your SEEF and SELF thresholds and actions. SEEF stands for Seek and Eliminate Excessive Flow and deals with how you want your controller to respond when excessive flow is occurring, as might be the case with a mainline break or a valve which is stuck in the open position. SELF stands for Seek and Eliminate Low Flow and deals with what the controller should do when low flow is present, as might be the case during a pump failure, municipal water supply issue or when a valve fails to open.

Set Up and Configure SEEF and SELF

▶ Turn the controller dial to Module Programming.



- 1 The Smart Module PGM screen appears with Flow Smart Module selected; press Next.
- 2 The Flow Smart Module PGM screen appears. Use the Down Arrow to select FloWatch; then press Next.

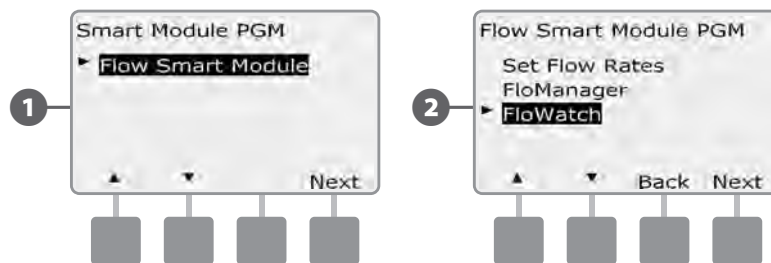

- 3 The FloWatch screen appears with SEEF/SELF Settings selected; press Next.
- 4 The SEEF Settings screen appears with high flow threshold selected, allowing you to set the top limit (between 105-200%) of station flow rate that must be achieved to be considered excessive. Press the + and - buttons to set the High flow Threshold; then press Next.
 - Press and HOLD buttons to accelerate settings for percentages.

NOTE: Consider using the default setting of 130% (or higher) for SEEF high flow threshold. Using a lower percentage can result in false alarms due to normal hydraulic variability.

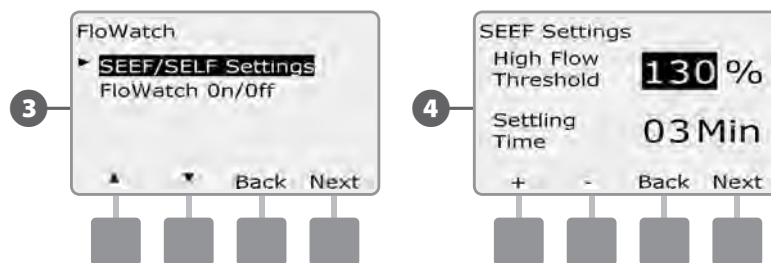

- 5 Settling Time is selected, allowing you to set the minimum time (from 1-10 minutes) that a flow rate must remain at (or above) the threshold before the controller will issue an alarm or take action. Press the + and - buttons to set the Settling Time; then press Next.

6 The SEEF Actions screen appears, allowing you to set the controller's behavior when a SEEF condition exists.

A. Diagnose and Eliminate allows the controller to determine if the high flow condition is due to a problem on the mainline (broken pipe, stuck valve, etc) or downstream of one of the valves that was running when the high flow condition was detected. The controller will eliminate the high flow condition by closing the FloZone master valve(s) to eliminate a mainline problem or closing the problem valve to eliminate a problem with a station.

! **NOTE:** If you choose the Diagnose and Eliminate action, be aware that all FloZones, stations and hardware, including FloZones unaffected by a SEEF or SELF and non-irrigation hardware, may be temporarily shut down during the SEEF or SELF diagnostic process. For this reason, if uninterrupted operation of non-irrigation hardware, even during a SEEF or SELF diagnostic procedure, is critical for your installation we recommend operating non-irrigation hardware with latching relays or selecting a SEEF and SELF Action other than Diagnose and Eliminate.

B. Shut Down and Alarm instructs the controller to shut down the master valve(s) on the FloZone when a high flow condition is detected. The controller will not attempt to diagnose if the problem is on the mainline or downstream of a valve.

C. Alarm Only allows the controller to issue an alarm condition, but take no other action.

Press the + and – buttons to set the SEEF Action; then press Next.

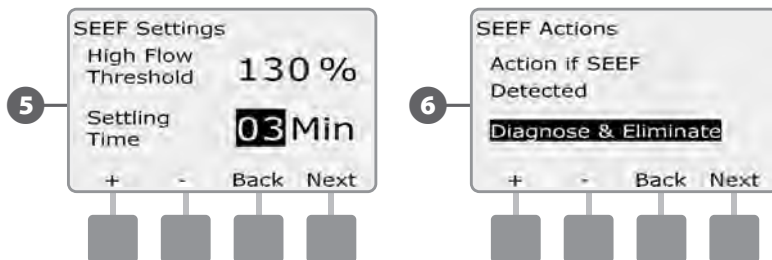

7 The SELF Settings screen appears with low flow threshold selected, allowing you to set the bottom limit (between 1-95%) that a station must achieve to be considered low flow. Press the + and – buttons to set the low flow threshold; then press Next.

- Press and HOLD buttons to accelerate settings for percentages.

! **NOTE:** Consider using the default setting of 70% (or lower) for SEEF low flow threshold. Using a higher percentage can result in false alarms due to normal hydraulic variability.

8 Settling Time is selected, allowing you to set the time limit (from 1-10 minutes) that a station flow rate must remain at (or below) the threshold before the controller will issue an alarm or take action. Press the + and – buttons to set the Settling Time; then press Next.



! **NOTE:** If you are using Cycle+Soak, be sure to set your SEEF and SELF settling times shorter than the cycle portion of your Cycle+Soak station runtimes. A SEEF or SELF condition can not be detected if the SEEF and SELF settling times are equal to or longer than station cycle times.

9 The SELF Actions screen appears, allowing you to set the controller's behavior when a SELF condition exists.

A. Diagnose and Eliminate allows the controller to determine if the low flow condition is due to a problem on the mainline (affects all valves in FloZone) or downstream of one of the valves that was running when the low flow condition was detected. The controller will eliminate the low flow condition by closing the FloZone master valve(s) to eliminate a mainline problem or closing the problem valve to eliminate a problem with a station.

B. Shut Down and Alarm instructs the controller to shut down the master valve(s) on the FloZone when a low flow condition is detected. The controller will not attempt to diagnose if the problem is on the mainline or downstream of a valve.

C. Alarm Only allows the controller to issue an alarm condition, but take no other action.

Press the + and – buttons to set the SELF Action; then press Next.

10 The Delay to Re-Enable screen appears, allowing you to select how long (from 0 to 24 hours) before your system is re-enabled and program starts are allowed.

NOTE: If you select a Delay to Re-Enable time of 00:00, the controller will not attempt to start irrigation again until you have cleared all SEEF and SELF alarms.

Press the + and – buttons to set hours before Re-Enable; then press Next.

- Press and HOLD buttons to accelerate settings for hours and minutes.

NOTE: If the selected action for **both** SEEF and SELF is Alarm Only, then the system is not disabled and the Delay to Re-Enable screen will not be shown.

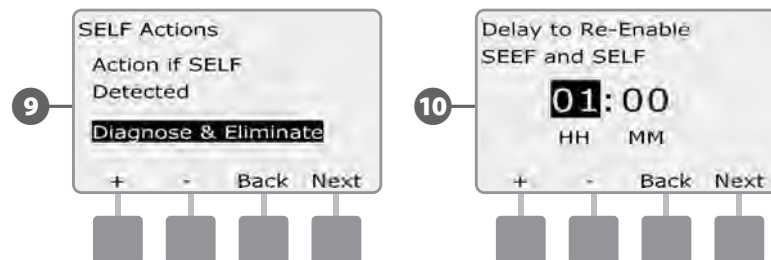

11 Press the + and – buttons to set minutes before Re-Enable; then press Next.

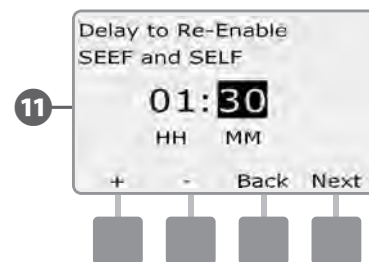

NOTE: SEEF and SELF settings are not active until FloWatch is activated. You may also wish to temporarily disable FloWatch occasionally, such as when normal maintenance is occurring.

Learn Flow

FloZone flow rates are either:

- Automatically set to the highest station flow rate assigned to the FloZone, or
- Manually adjusted by the user.

Learn Flow Automatically (All Stations)

▶ Turn the controller dial to Module Programming.

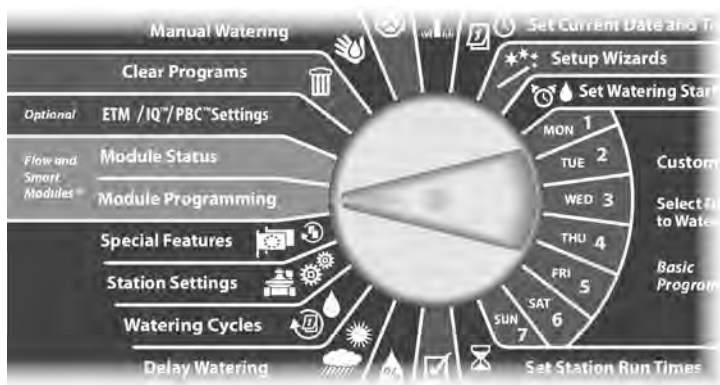

- The Smart Module PGM screen appears with Flow Smart Module selected; press Next.
- The Flow Smart Module PGM screen appears with Set Flow Rates selected; press Next.

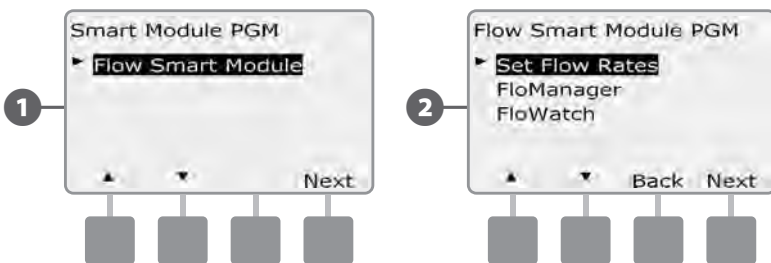

- The Set Flow Rates screen appears with Learn Flow selected; press Next.
- The Learn Flow screen appears with All stations selected; press Next.

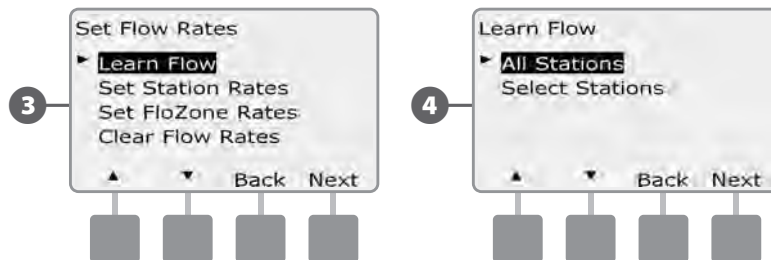

! **NOTE:** Ensure you have runtimes set up for all stations included in a Learn Flow exercise prior to setting up a Learn Flow.

- Press the + and – buttons to set the time when you want the Learn Flow exercise to start; then press Next.
 - Press and HOLD buttons to accelerate settings for hours and minutes.

! **NOTE:** You can choose to run the exercise Now or choose a timed delay of up to 24 hours.

- A confirmation screen appears; press Next again to set the Learn Flow exercise.

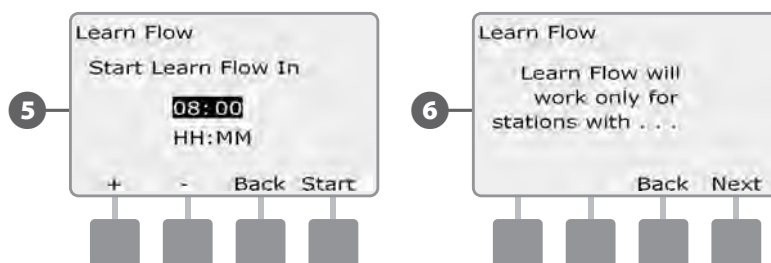

- 7 The Learn Flow Starting confirmation screen appears, confirming the delay time until the Learn Flow operation will start.

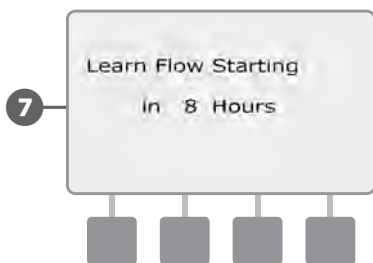

- NOTE:** To ensure accurate recording of flow rates, do not create any manually-generated flow such as flow created with manually operated quick coupling valves, while a Learn Flow is taking place.
- NOTE:** Be sure to Learn Flow again if you make any changes to your system which affect its hydraulics.
- NOTE:** If the flow rates for one or more stations seem low, check your flow metering hardware and flow sensor. Low flow readings can be caused by faulty flow meters or flow sensors.

Learn Flow Automatically (Custom Stations)

- Turn the controller dial to Module Programming.



- 1 The Smart Module PGM screen appears with Flow Smart Module selected; press Next.
- 2 The Flow Smart Module PGM screen appears with Set Flow Rates selected; press Next.

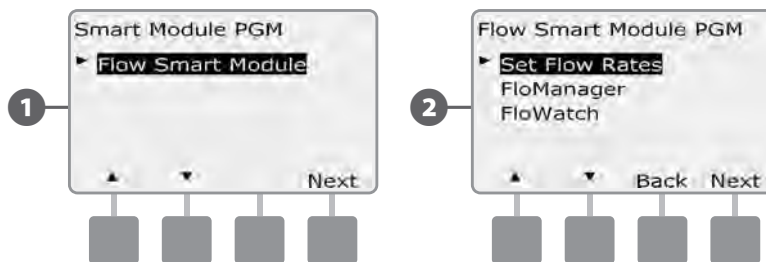

3 The Set Flow Rates screen appears with Learn Flow selected; press Next.

! **NOTE:** Ensure you have runtimes set up for all stations included in a Learn Flow exercise prior to setting up a Learn Flow. If stations without run times are included in a Learn Flow exercise, the controller will issue an error message and cancel the Learn Flow exercise.

4 The Learn Flow screen appears. Press the Down Arrow to choose Select stations; then press Next.



5 Press the Yes and No buttons to select the stations you would like to include. Press Next and Back buttons to select stations; then press Next.

6 Press the + and - buttons to set the timed delay when you want the Learn Flow exercise to start; then press Start.

- Press and HOLD buttons to accelerate settings for hours and minutes.

! **NOTE:** You can choose a delay between 0 hours, 0 minutes up to 24 hours.

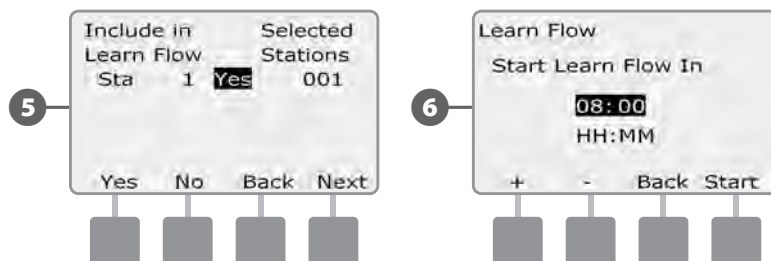

7 A confirmation screen appears; press Start again to set the Learn Flow exercise.

8 The Learn Flow Starting confirmation screen appears, confirming the delay time until the Learn Flow operation will start.

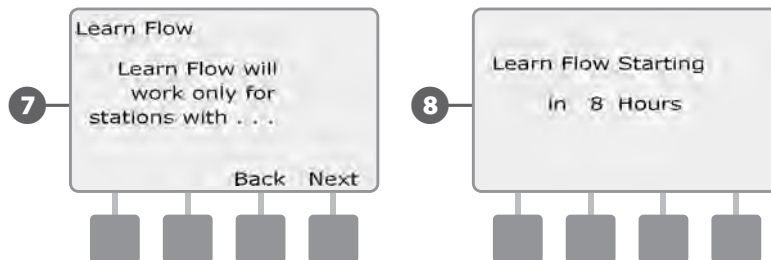

! **NOTE:** Station or FloZone flow rates can still be entered manually. See Set Flow Rates Manually in the FloWatch section.

View and Clear Flow Alarms

Occasionally a flow condition in excess of your SEEF settings or below your SELF settings will be detected. If your controller is set up to issue alarms for these conditions, the alarm light will illuminate and detailed descriptions of the Flow Alarm conditions will be created.

View Station Flow Alarms

Turn the controller dial to Module Status.



- 1 The Smart Module Status screen appears with Flow Smart Module selected; press Next.
- 2 The Flow Module Status screen appears with View Flow Alarms selected; press Next.

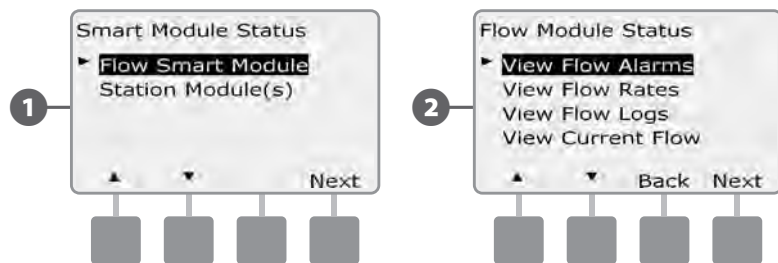

- 3 The Review/Clear Alarms screen appears with station Flow Alarms selected; press Next.
- 4 The station Flow Alarms screen appears. Press the + and - buttons to view other station flow alarms.

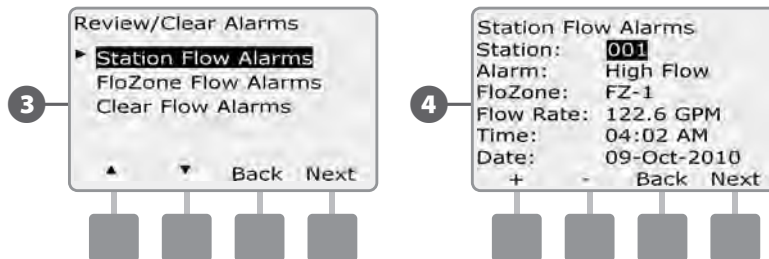

Note each station which has an alarm, then see Clear Flow Alarms in this section for more details on how to clear flow alarms.

View FloZone™ Flow Alarms

- 1 Turn the controller dial to Module Status.



- 2 The Smart Module Status screen appears with Flow Smart Module selected; press Next.
- 3 The Flow Module Status screen appears with View Flow Alarms selected; press Next.

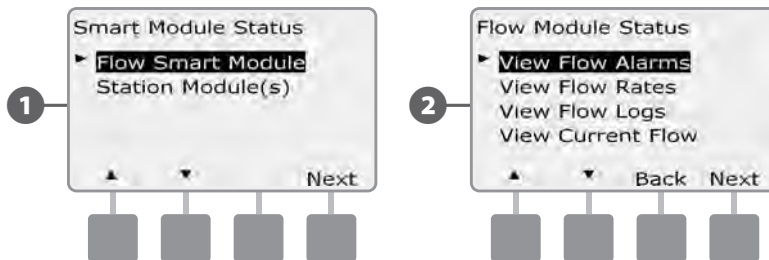

- 4 The Review/Clear Alarms screen appears. Press the Down Arrow button to select FloZone Flow Alarms; then press Next.
- 5 The FloZone Flow Alarms screen appears. Press the + and - buttons to view other FloZone flow alarms.

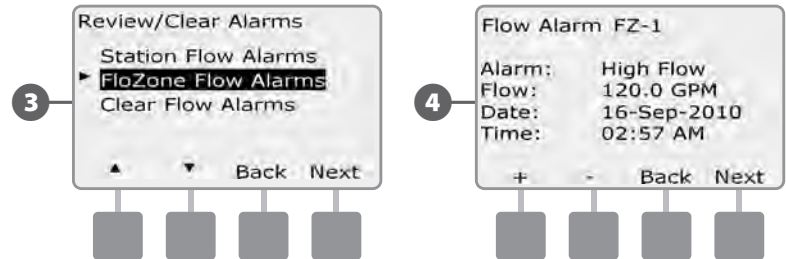

Note each station which has an alarm, then See Clear Flow Alarms in this section for more details on how to clear flow alarms.

Clear Flow Alarms

- ▶ Turn the controller dial to Module Status.



- 1 The Smart Module Status screen appears with Flow Smart Module selected; press Next.
- 2 The Flow Module Status screen appears with View Flow Alarms selected; press Next.

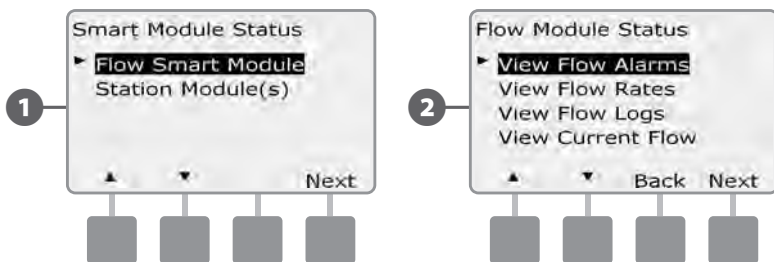

- 3 The Review/Clear Alarms screen appears. Press the + and – button to select Clear Flow Alarms; then press Next.
- 4 The Clear Flow Alarms screen appears. Press Yes to clear all station and FloZone flow alarms.

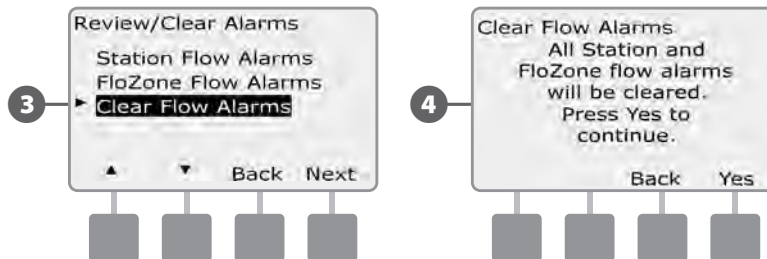

View Flow Rates

Occasionally you may want to view flow rates and their source for a station or flow zone.

View Flow Rates for Stations

- 1 Turn the controller dial to Module Status.



- 1 The Smart Module Status screen appears with Flow Smart Module selected; press Next.
- 2 The Flow Module Status screen appears. Press the Down Arrow button to select View Flow Rates; then press Next.

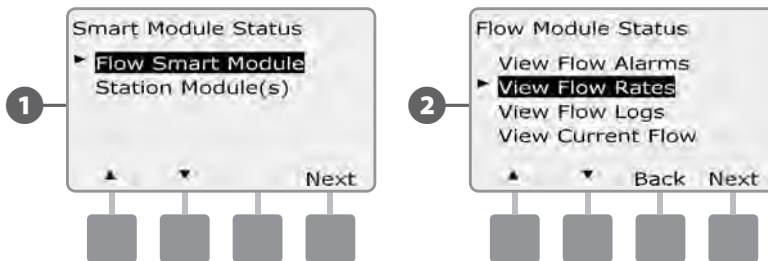

- 3 The Flow Rates screen appears with View station Rates selected; press Next.
- 4 The station Flow Rates screen appears. Press the + and - buttons to select the desired station number. The flow zone for each station displays below it. The normal flow rate for each station will display to the right, and the source of the flow rate (Learned or User Entered) displays below it.

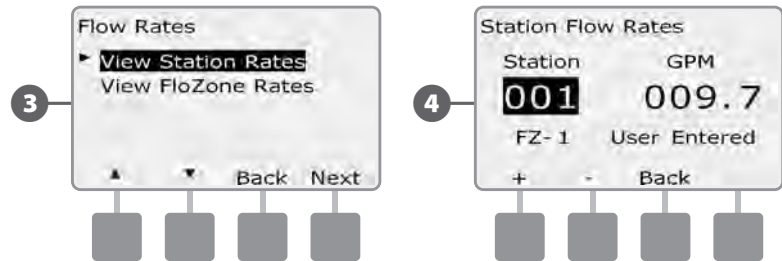

View Flow Rates for FloZones™

Turn the controller dial to Module Status.



- 1 The Smart Module Status screen appears with Flow Smart Module selected; press Next.
- 2 The Flow Module Status screen appears. Press the Down Arrow button to select View Flow Rates; then press Next.

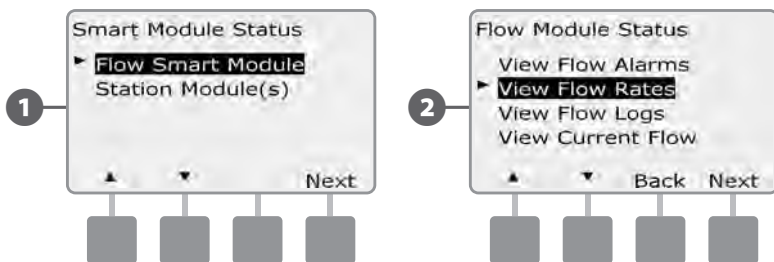

- 3 The Flow Rates screen appears. Press the Down Arrow button to select View FloZone Rates; then press Next.
- 4 The FloZone Flow Rates screen appears. Press the + and - buttons to select the desired FloZone number. The MVs and sensors associated with that flow zone display below it. The maximum flow rate for that flow zone will display to the right.

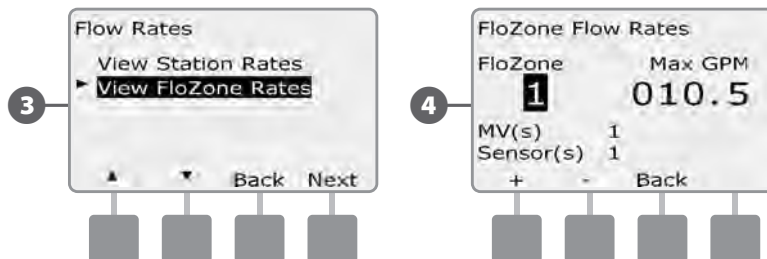

View and Clear Flow Logs

With FloWatch enabled, the controller will automatically track the volume of water flowing through the system. This can be useful for checking your actual water consumption against your water bill.

▶ Turn the controller dial to Module Status.



1 The Smart Module Status screen appears with Flow Smart Module selected; press Next.

2 The Flow Module Status screen appears. Press the Down Arrow button to select View flow Logs; then press Next.

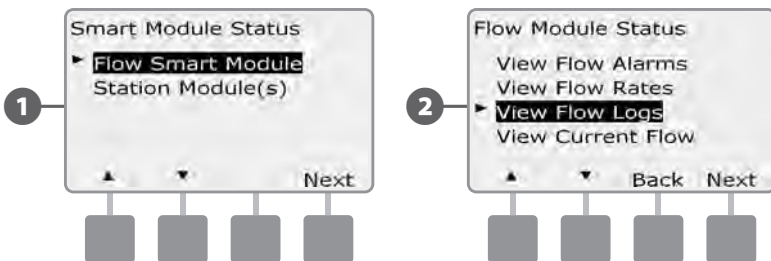

3 The Flow Logs screen appears, showing month-to-date and last month water consumption (in gallons).

4 Press the Days button to change the view to the last 30 days and previous 30 days.

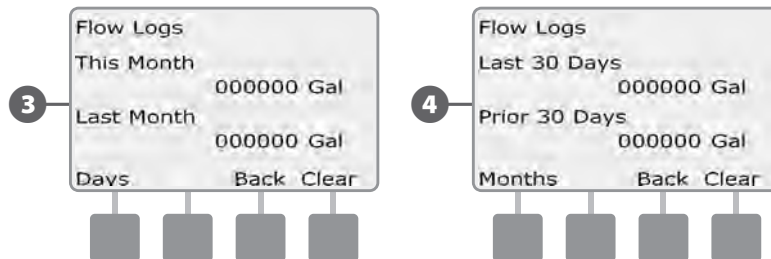

5 If you would like to clear the log information, press the Clear button.

NOTE: Pressing Clear from either the monthly or daily screen will clear BOTH monthly and daily flow log data.

6 The confirmation screen appears; press Yes to clear the logs.

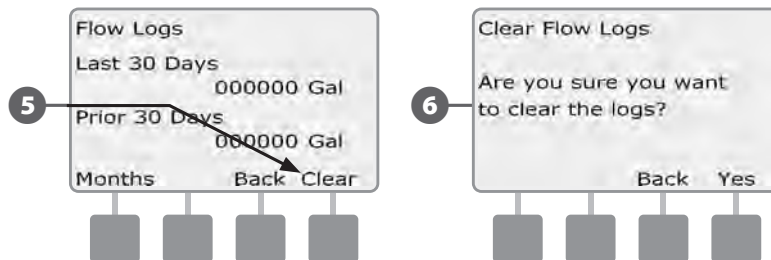

View Current Flow

Occasionally it may be useful to check the current flow rate in a particular FloZone and how that compares to previously learned or user input flow rates.

- Turn the controller dial to Module Status.

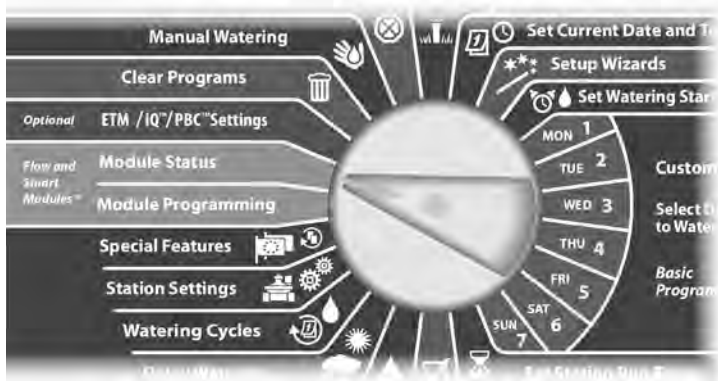

- The Smart Module Status screen appears with Flow Smart Module selected; press Next.
- The Flow Module Status screen appears. Press the Down Arrow button to select View Current flow; then press Next.

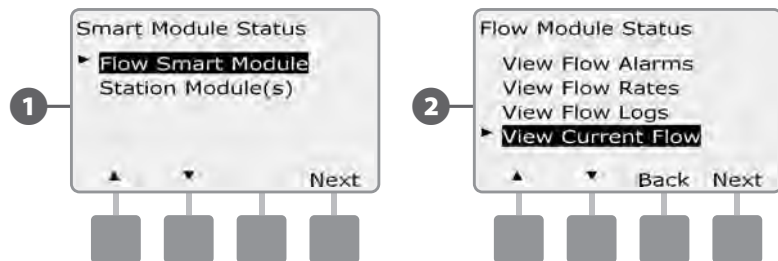

- The View Current Flow screen appears. Press the + and – buttons to select the desired FloZone number. Current and expected flow will display.

NOTE: Expected flow is from previously user-entered or learned flow. The deviation or percentage comparison of current flow to expected flow will display so you can see how close each FloZone is to a SEEF or SELF condition (see Setting Up SEEF and SELF for more details).

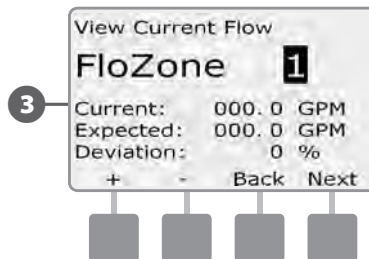

Clear Flow Rates

Occasionally it may be desired to clear the previously learned or user entered flow rates and start all over again.

▶ Turn the controller dial to Module Programming.

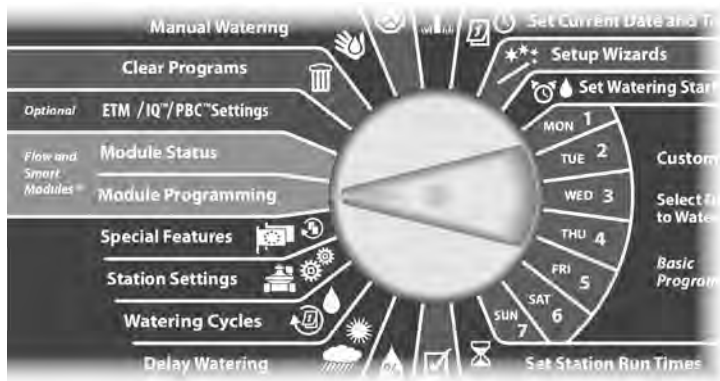

- 1 The Smart Module PGM screen appears with Flow Smart Module selected; press Next.
- 2 The Flow Smart Module PGM screen appears with Set Flow Rates selected; press Next.

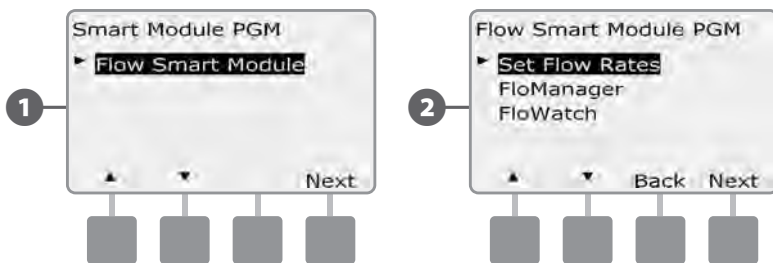

- 3 The Set Flow Rates screen appears. Press the Down Arrow button to select Clear Flow Rates; then press Next.
- 4 The confirmation screen appears; press Next to clear flow rates.

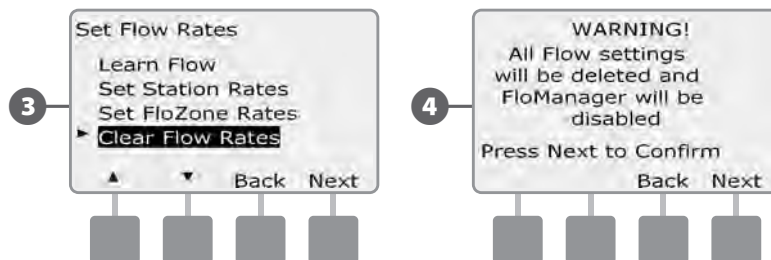

this page intentionally left blank

Section G - Auxiliary Operation

Module Status

Confirm that your ESP-LXD controller recognizes installed Station Modules.

The standard ESP-LXD-M50 module will use two of the four available slots. You can also expand station capacity by 75-150 stations by installing one or two ESP-LXD-SM75 Station Modules.

Smart Module Status

Check Station Module(s)

Turn the controller dial to Module Status.



- 1 The Smart Module Status screen appears. Use the Down Arrow to select Station Module(s); then press Next.
- 2 The LXD Station Modules screen appears showing all recognized modules. Press Back to return to the previous screen or press Next to review flow and Weather Sensors.

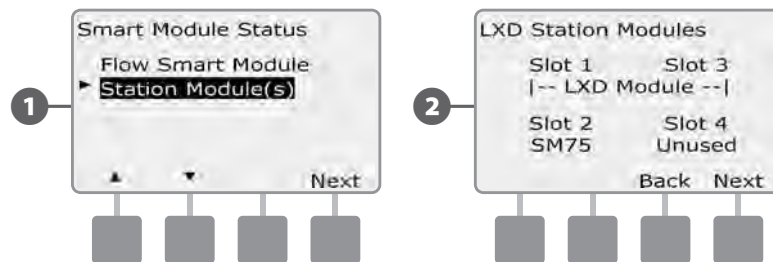

- 3 Pressing Next displays the number of supported flow and weather sensors.

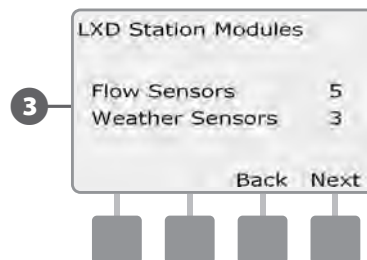

- NOTE:** If the controller does not recognize an installed module, carefully remove it and review the installation instructions in Section H of this manual. Then re-install the module and repeat this process.

Clear Programs

The ESP-LXD controller allows you to clear an individual Program, all of your Programs or Restore the controller to it's factory default condition.

CAUTION: It's recommended to back up your Programs before clearing them. The ESP-LXD controller's built in Store Programs feature can backup one set of programs. See Section E, Backup and Recall for more details.

NOTE: Irrigation start days, Start Times and station Run Times will no longer be present for the cleared Programs. If no Programming exists then an Alarm will be displayed. See Section A, Alarm Conditions for more details.

Clear Individual Program

Turn the controller dial to Clear Programs.



1 The Clear Programs screen appears with Individual Program selected; press Next.

2 A confirmation screen appears. To clear the selected Program, press and hold down the Yes button for four seconds. If you're not sure, press No.

NOTE: If the desired Program is not selected, use the Program Select switch to change it. See Program Selection in Section A for more details.

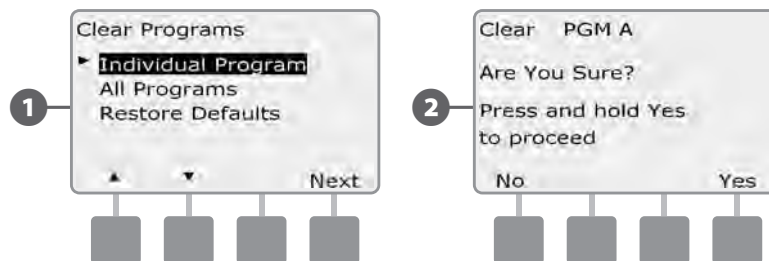

3 A confirmation screen appears.

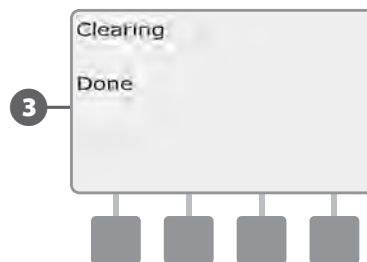

Change the Program Select switch and repeat this process to clear other Programs.

Clear All Programs

Turn the controller dial to Clear Programs.



- 1 The Clear Programs screen appears. Press the Down Arrow button to select All Programs; then press Next.
- 2 A confirmation screen appears. To Clear All Programs, press and hold down the Yes button for four seconds. If you're not sure, press No.

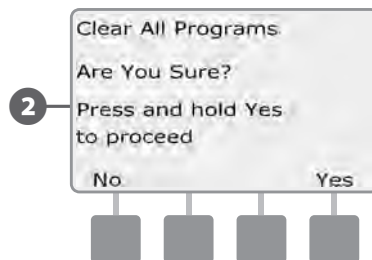
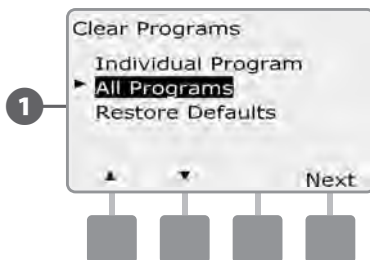

- 3 A confirmation screen appears.

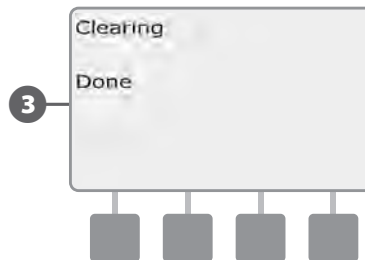

Restore Defaults

Restore the ESP-LXD controller's factory default settings.

Turn the controller dial to Clear Programs.



3 A confirmation screen appears.

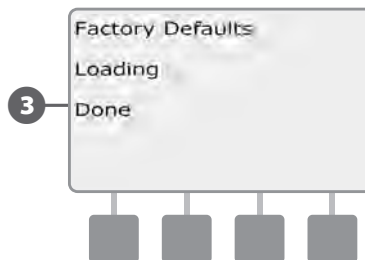

CAUTION: Be very careful about using the Restore Defaults option as all previous settings, including decoder addresses, will be permanently cleared from system memory. Consider using the Clear All Programs option instead so that your decoder addresses will not be erased.

1 The Clear Programs screen appears. Press the Down Arrow button to select Restore Defaults; then press Next.

2 A confirmation screen appears. To Restore Factory Defaults, press and hold down the Yes button for four seconds. If you're not sure, press No.

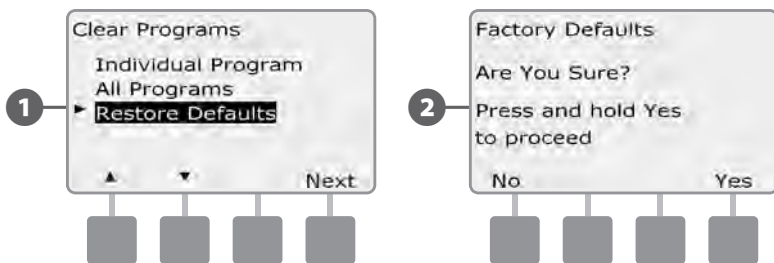

Manual Watering

The ESP-LXD controller allows you to manually start a station, a program, or to open a Normally Closed Master Valve (NCMV) to provide water to a FloZone for manual watering.

Start Station Manually

! **NOTE:** Manual Watering > Start Station will pause currently running programs.

! **NOTE:** Ensure decoder addresses are present and entered correctly prior to Manual Station or Manual Program operations.

 Turn the controller dial to Manual Watering.



1 The Manual Watering screen appears with Start Station selected; press Next.

2 The Manual Watering screen appears. Press the + and – buttons to enter the station you want to run manually; then press Next.

- Press and HOLD buttons to accelerate settings for hours and minutes.

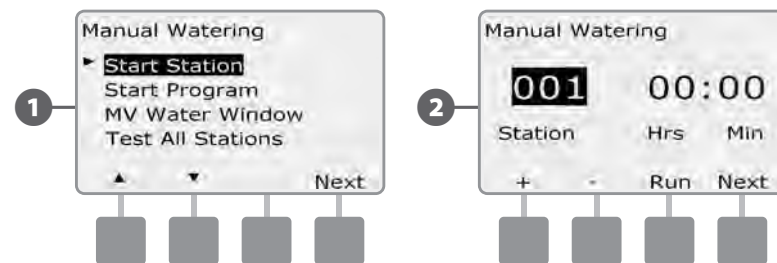

3 The Station Run Time will default to the Program Run Time. Press the + and – buttons to adjust the station Run Time (from 0 hours, 1 minute to 12:00 hours). Press the Run button to start irrigation for that station.

4 A confirmation screen appears.

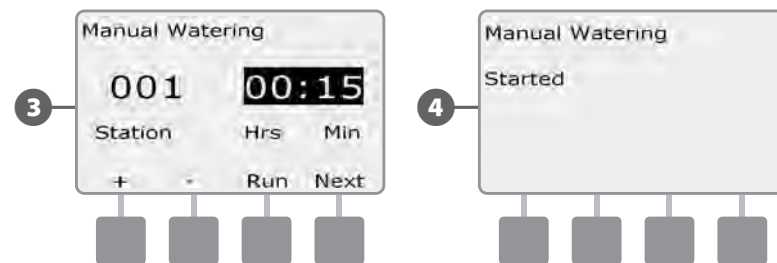

 Repeat this process to manually water other stations.

! **NOTE:** stations will run sequentially in the order in which they were selected.

! **NOTE:** To view the Station while running, turn the controller dial to AUTO position. You can use the Adv button to advance to the next station and the + and – buttons to increase or decrease the Run Time of the current station.

Start Program Manually

Turn the controller dial to Manual Watering.



1 The Manual Watering screen appears. Press the Down Arrow button to select Start Program; then press Next.

2 The Manual Watering Start Program screen appears. Press Run to start the Program or else press Back to cancel.

NOTE: If the desired Program is not selected, use the Program Select switch to change it. See Program Selection in Section A for more details.

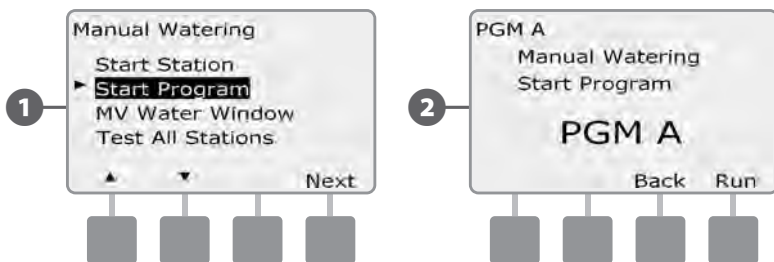

3 A confirmation screen appears.

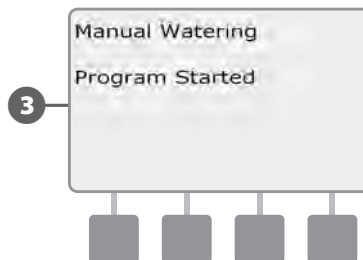

Repeat this process to manually start other Programs. Programs will run sequentially in the order in which they were selected.

NOTE: To view the Program while running, turn the controller dial to AUTO position. You can use the Adv button to advance to the next station and the + and – buttons to increase or decrease the Run Time of the current station.

MV Water Window

Sometimes you may want to use quick coupling valves or other manual watering methods during times when you are not irrigating. To ensure that these devices have water, you can set up an MV Water Window. The MV Water Window works the same way as other Water Windows, but instead of allowing irrigation it simply opens Normally Closed master valves (NCMV's) and allows a user-defined flow rate to coordinate with flow sensing.

Set Up MV Water Window

 Turn the controller dial to Manual Watering.



- 1 The Manual Watering screen appears. Press the Down Arrow button to select MV Water Window ; then press Next.
- 2 The MV Water Window screen appears with MV Water Window selected; press Next.

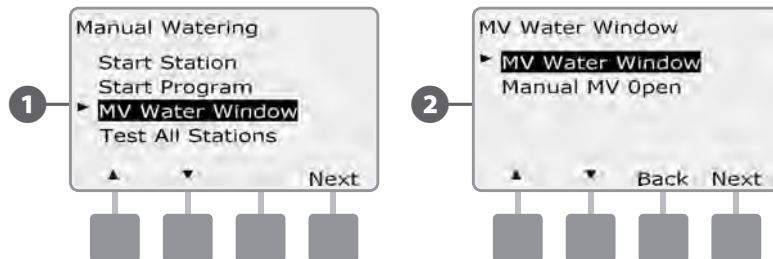

- 3 Press the + and – buttons to set the time when the MV Water Window opens; then press Next.
 - Press and HOLD buttons to accelerate settings for hours and minutes.
- 4 Press the + and – buttons to set the time when the MV Water Window closes. As you adjust the end time, the duration of your MV Water Window calculates automatically; then press Next.

 **NOTE:** To clear a previously set MV Water Window, press the + and – buttons to set both the Open and Close times to OFF (between 11:59 and 12:00 AM).

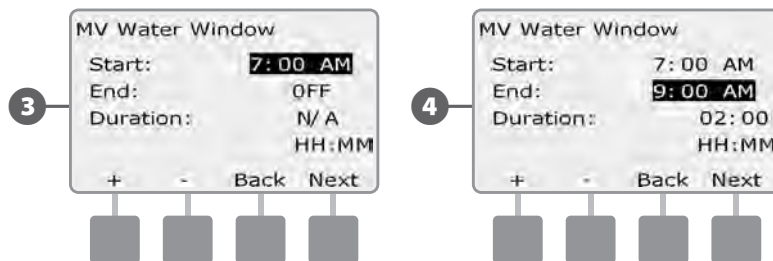

5 The MV Manual Watering Allowed On screen appears. Press the Yes button to allow MV Manual Watering to occur on a given day or press No to exclude that day.

6 Press the Next and Back buttons to navigate through the days of the week and repeat the selection process as desired; then press Next to navigate past Sunday.

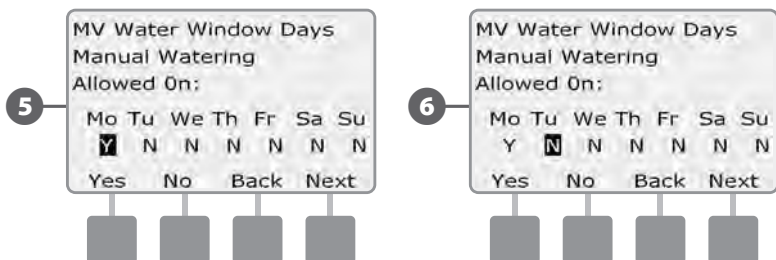

9 If FloWatch is enabled, the controller will request incremental flow allowed for the MV Water Window. Press the + and - buttons to enter a sufficiently large value so that flow from hoses and other manual watering devices will not trigger a false SEEF alarm.

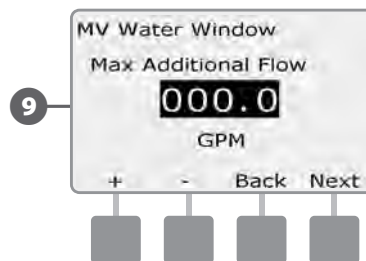

7 The MVs included in Water Window screen appears allowing you to choose which MVs to include in the MV Water Window. Press the Yes button to include the selected MV in the Water Window or press No to exclude it.

8 Press the Next and Back buttons to navigate through the days of the week and repeat the selection process as desired.

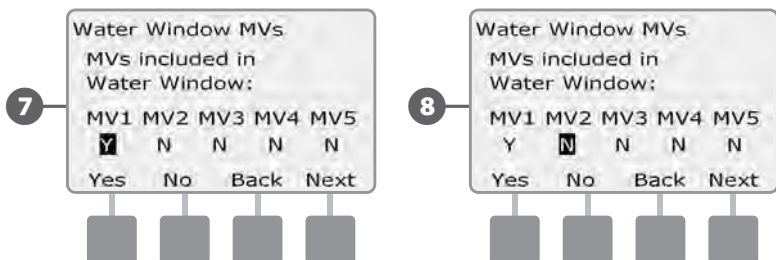

Manually Opening a MV

Occasionally it may be necessary to provide water to the system for unscheduled tasks. The Open MV feature allows you to leverage settings, such as allowable incremental flow, from your MV Water Window to open MVs for a short time.

- 1 Turn the controller dial to Manual Watering.



- 2 The Manual Watering screen appears. Press the Down Arrow button to select MV Water Window ; then press Next.
- 3 The MV Water Window screen appears. Press the Down Arrow button to select Manual MV Open ; then press Next.

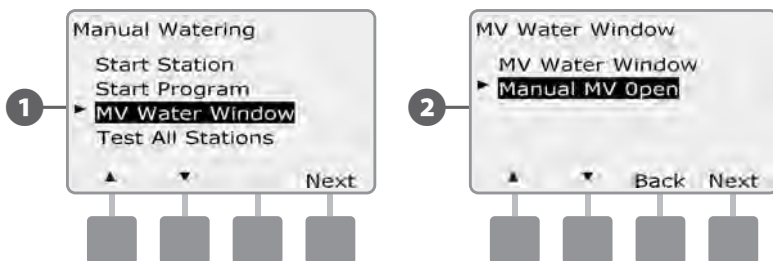

- 4 The Manual MV Open screen appears, showing all MVs that were previously selected to be included in the MV Water Window; press Next
- 5 The Manual MV Open screen appears. Press the + and – buttons to set the duration (in hours and minutes) for the MV to be open; then press Start.

- Press and HOLD buttons to accelerate settings for hours and minutes.

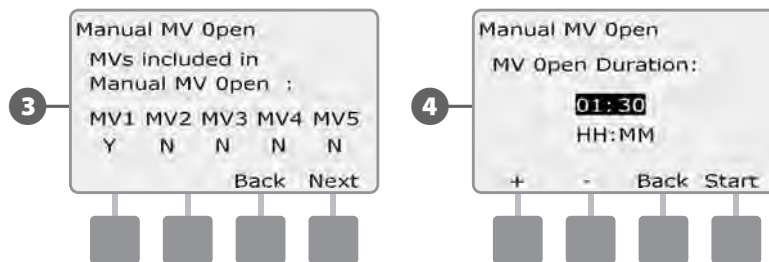

Test All Stations

You can test all stations connected to your controller by running each of them in station number sequence.

Sometimes this is useful after installation, for general maintenance or as a first step in troubleshooting your system.

NOTE: Only stations with programmed run times are included in the Test All Stations operation.

Turn the controller dial to Manual Watering.



- 1 The Manual Watering screen appears. Press the Down Arrow button to select Test All stations; then press Next.
- 2 The Test All stations screen appears. Press the + and - buttons to adjust the Test Run Time (adjustable from 1 to 10 minutes) per station; then press Run.

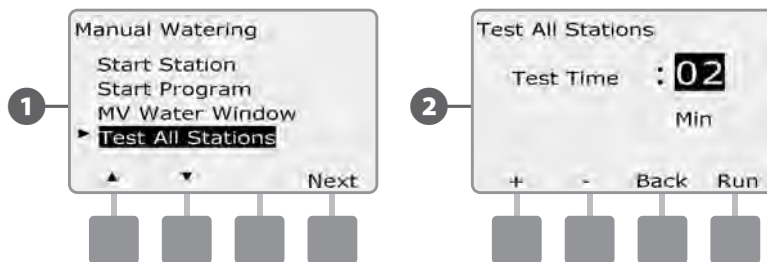

- 3 A confirmation screen appears.
- 4 Once Run is pressed, stations can be monitored and advanced by turning the dial to the AUTO position and using the Adv button. Press the + and - buttons to increase or decrease Run Time minutes for the current station.



this page intentionally left blank

OFF

Turn off irrigation, master valves or the 2-Wire path.

Adjust Display Contrast

Adjust the contrast settings for the controller display for better visibility.

▶ Turn the controller dial to OFF.



1 The All Watering Off screen appears and the current contrast adjustment setting will display for 10 seconds. Press the + and - buttons to adjust contrast up or down.

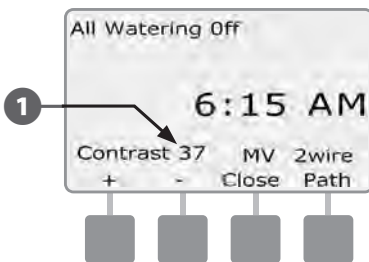

Turn Off 2-Wire Path

Sometimes you may want to turn off the 2-Wire path, such as when you're maintaining your system. The ESP-LXD controller lets you do this automatically so you do not need to un-wire the 2-Wire path from the connection lugs.

⚠ **CAUTION:** Always turn off 2-Wire path before maintaining hardware connected to the 2-Wire path. The 2-Wire path is always powered even when irrigation is not scheduled.

! **NOTE:** Irrigation functions, including: flow sensors, weather sensors and field decoders will be non-operational when the 2-Wire path is powered down.

Power Down or Restore Power to the 2-Wire Path

▶ Turn the controller dial to OFF

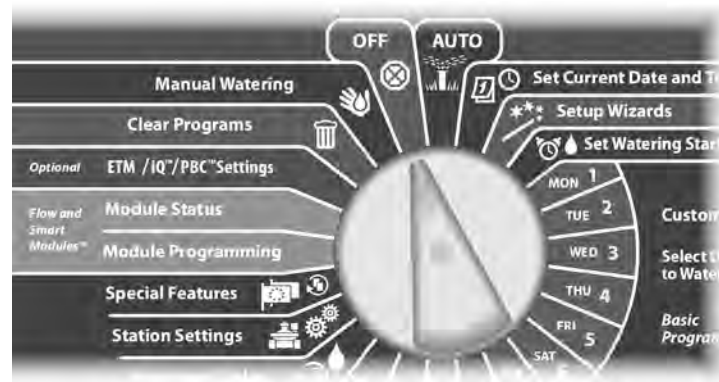

- 1 From the Off main screen, press the 2-Wire Path button.
- 2 The 2-Wire Path On/Off screen will appear. Normally the 2-Wire path will be ON, unless you have previously turned it off. Press the Off button.

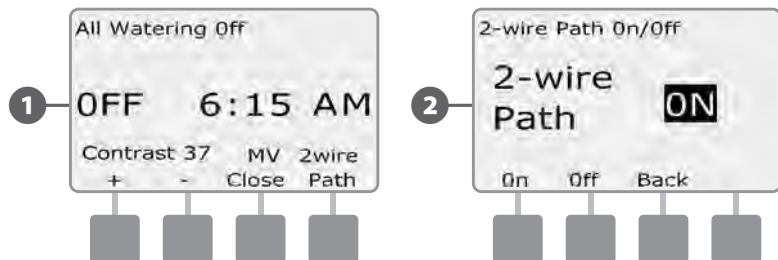

- 3 A confirmation screen appears. To turn off the 2-Wire path, press and hold down the Yes button for four seconds. If you're not sure, press No.
- 4 A confirmation screen appears.

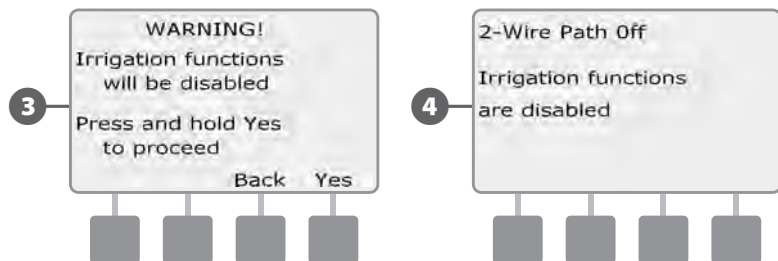

- 5 The OFF dial position screen will now display the message "2-Wire Path Off".

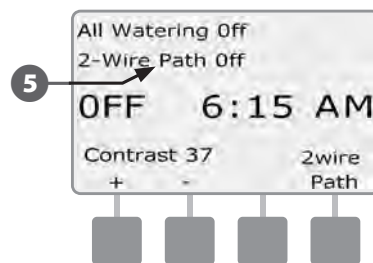

- Repeat this process and press the On button to restore power to the 2-Wire path.

NOTE: It's not necessary to leave the controller dial in the OFF position when the 2-Wire path is off. You can still change Programs or perform other tasks. But while the 2-Wire path is powered down, the controller's alarm light will be lit and a 2-Wire Path Off message will be displayed whenever the controller dial is at the OFF or AUTO dial positions.

Close Master Valves

Closes all master valves, disabling irrigation.

CAUTION: Using the MV Close function will disable all irrigation functions.

NOTE: The Close Master Valves function closes Normally Open Master Valves. Normally Closed Master Valves remain closed.

Turn the controller dial to OFF.



- 3 A confirmation screen appears.
- 4 The OFF dial position screen will now display the message “All MV’s Closed”. To cancel and restore irrigation functions, turn the dial to AUTO.

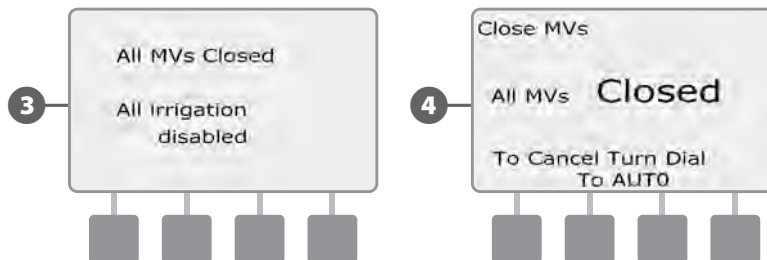

- 1 The All Watering Off screen appears. Press the MV Close button.
- 2 A confirmation screen appears. To close all master valves, press and hold down the Yes button for four seconds. If you’re not sure, press Back.

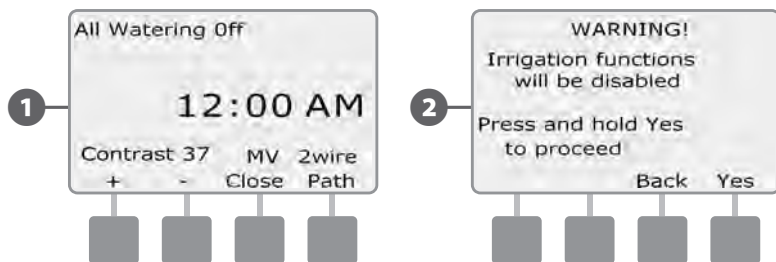

Section H - Installation

Install the Controller

This section explains how to mount the ESP-LXD controller on a wall (or mounting surface) and connect the wiring.

NOTE: An optional metal cabinet (LXMM) and pedestal (LXMMPED) are also available for the ESP-LXD controller. If you intend to purchase those options then follow the installation instructions included with those items and proceed to the Install Modules section below.

WARNING: This controller must be installed in compliance with local electrical codes.

Installation Checklist

When installing the ESP-LXD controller for the first time, it is recommended that you complete the following steps in order.

For your convenience a check-off box is provided for each step.

- Check box contents.....Page 113
- Select a locationPage 114
- Gather installation toolsPage 114
- Mount the controllerPage 116
- Install LXD modulePage 117
- Install expansion module(s).....Page 118
- Connect field wiring.....Page 119
- Connect source powerPage 120
- Complete the installationPage 122

Check Box Contents

All components below are included with your ESP-LXD controller and are required for installation. If anything is missing, please contact your distributor before proceeding.

- 1 ESP-LXD controller.
- 2 Mounting hardware (5 screws, 5 plastic wall anchors).
- 3 Controller cabinet keys.
- 4 ESP-LXD Controller Installation, Programming, & Operation Guide.
- 5 ESP-LXD Controller Programming Guide.
- 6 Controller mounting template.

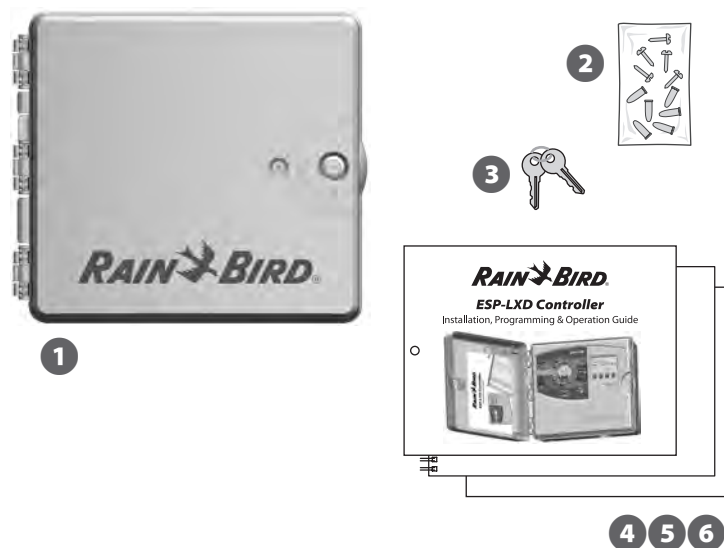

Box Contents

Select Location for Controller

Select a location that:



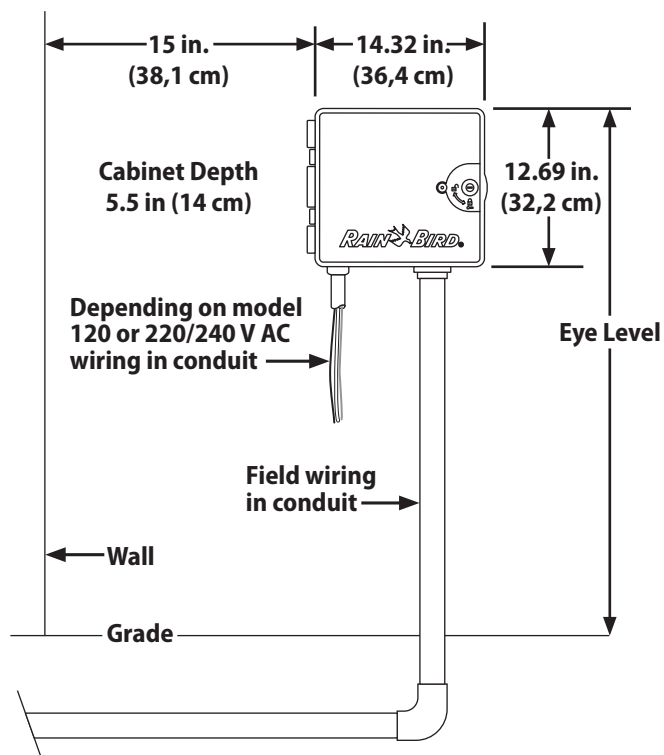



- Is easily accessible
- Allows for comfortable viewing
- Has a flat wall surface
- Near 120 V or 230/240 V AC power source (depending on model)
- Is safe from potential vandalism
- Is outside the range of operating sprinklers

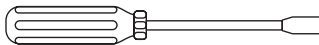
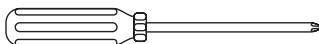

Select Controller Location

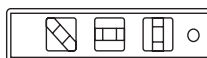
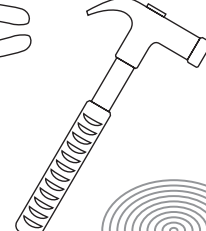
Gather Installation Tools

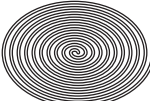
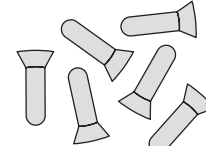
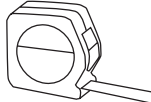
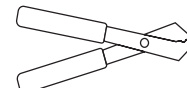
Before beginning installation, gather the following tools and materials:

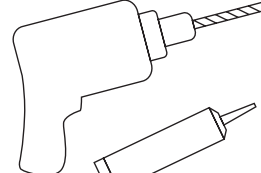
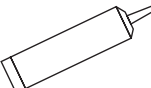
- Slotted Head Screwdriver 
- Phillips Head Screwdriver 
- Thin Blade Screwdriver 
- Lineman's Pliers 
- Torpedo Level 
- Hammer 
- Grounding Strap 
- 2-Wire MAXI Cable (#14 AWG wire) 
- #8 AWG or #10 AWG Bare Ground Wire 
- 3M DBR/Y Connectors 
- Tape Measure 
- Wire Stripper 
- Wire Nuts 
- Marking Pencil 
- Electric Drill (or Hammer Drill if installing in masonry or concrete wall) 
- Waterproof Caulking 

Access Controller Cabinet

Open or Remove Controller Front Panel

- 1 The controller comes with an outer door lock to deter vandalism and prevent unauthorized access to controller operations. If necessary, unlock the cabinet door using the supplied key.
- 2 To open the controller door: grasp the crescent-shaped handle on the right-hand-side of the outer cabinet.



- 3 Pull it towards you to open the door, swinging it to the left.
- 4 To open the controller front panel: grasp the crescent-shaped handle on the right-hand-side of the front panel.



- 5 Pull it towards you to open the front panel, swinging it to the left.

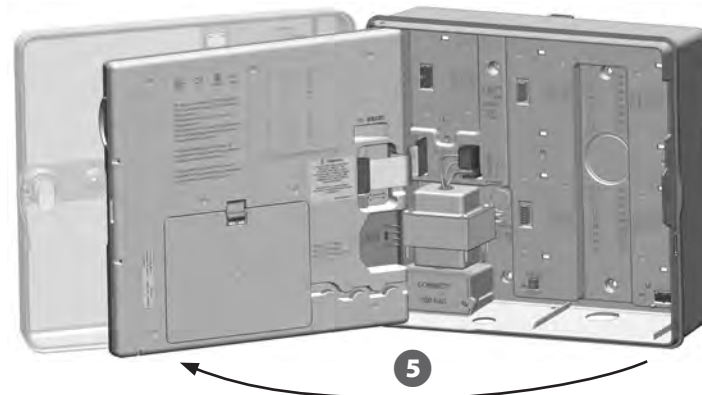

- 6 To remove the front panel: disconnect the ribbon cable from the front panel by gently pulling the connector out of the socket.



CAUTION: Be careful not to bend the pins in the sockets when attaching or detaching the ribbon cable.

- 7 Rock the front panel upward and nudge the bottom corner pin out of the lower pin-hole to remove the front panel.

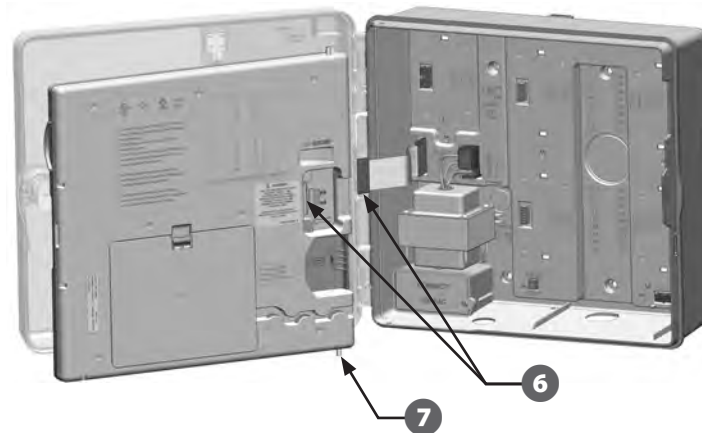

Mount Controller

! **NOTE:** Before mounting the controller, we recommend that you remove the controller front panel, plus decoder and/or station modules if previously installed.

- 1 Using a level, tape the mounting template to the mounting surface at approximately eye level. Make sure that at least one of the five mounting hole marks is aligned on a wall stud or other solid surface.
- 2 Use a tapping tool (or nail) and hammer to tap pilot holes through the five mounting hole marks and into the mounting surface. Then remove the template and drill holes in the mounting surface, installing wall anchors if necessary.

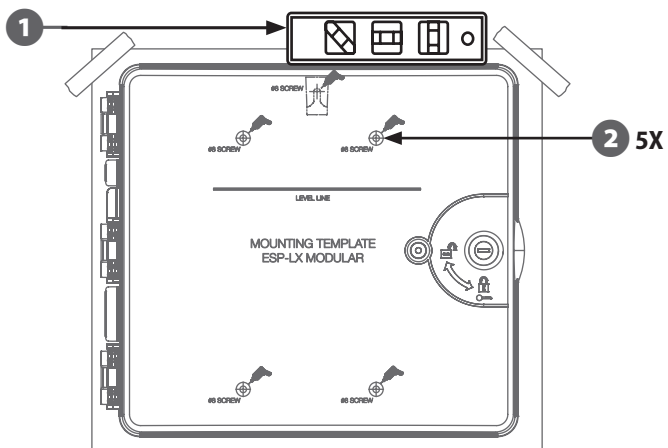

- 3 Drive the first screw into the topmost-center hole. Then hang the controller on the screw by the key-hole slot on the back of the cabinet.
- 4 Line up the controller cabinet mounting holes with the remaining pilot holes and drive the four remaining screws through the cabinet back plane into the mounting surface.

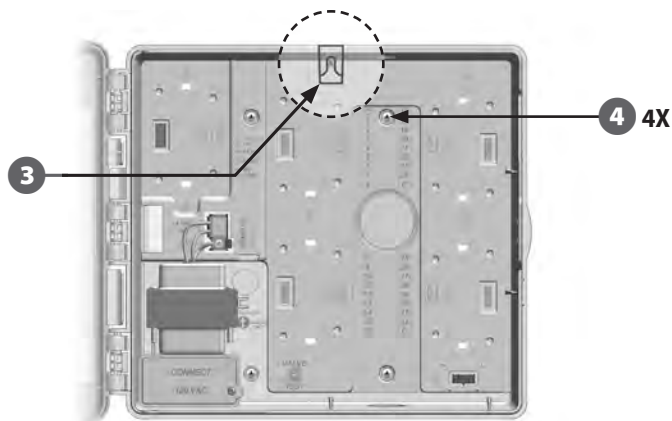

Install Modules

Install LXD Decoder Module

An ESP-LXD-M50 module is required for operation and is included with every ESP-LXD controller. The ESP-LXD-M50 module powers and provides an interface from the controller to the two wire path.



ESP-LXD-M50 Module

The ESP-LXD-M50 module must be installed horizontally in the controller cabinet, as shown. The module can be connected to either the top set of connectors (module slots 1 and 3) or the bottom set of connectors (module slots 2 and 4) on the controller backplane. We recommend installing the module into the top set of connectors unless you plan to upgrade your controller with an optional ET Manager cartridge. If you plan to add the ET Manager then we recommend installing the module into the bottom set of connectors to allow more space for installation and cable routing of the ET Cartridge Receiver (antenna).



CAUTION: Be careful not to bend the pins in the sockets when installing the module.

- 1 Orient the connectors on the bottom of the module with the connection sockets on the controller backplane.

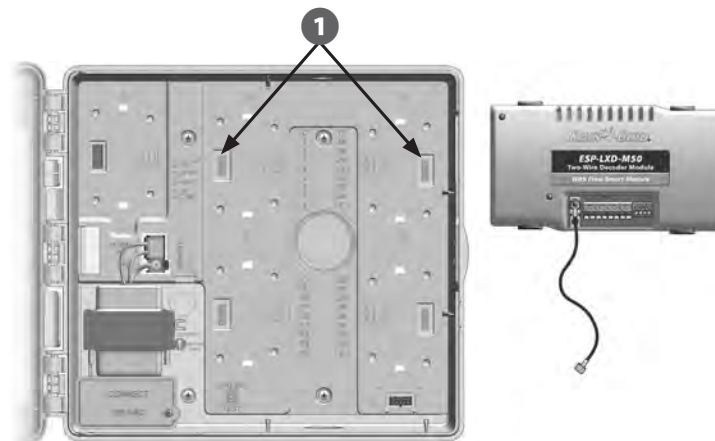

- 2 Carefully fasten the module onto the controller backplane, pressing firmly until it snaps into place.
- 3 Connect the green ground wire to the ground post on the left side of the controller backplane.

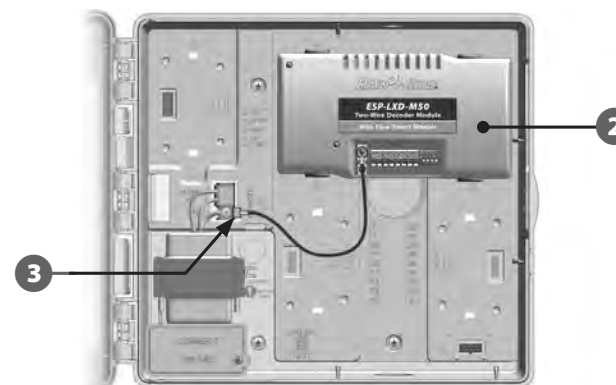

- NOTE:** To remove the module again, press in on the (four) release buttons on either side of the module.

Install Station Expansion Modules

The ESP-LXD controller comes standard with 50 stations available. This can easily be expanded by adding one or two optional ESP-LXD-SM75 Station Modules. Each station module adds 75 additional stations to increase capacity to 125 or 200 stations.



ESP-LXD-SM75 Station Expansion Module

Once your LXD Decoder module is correctly installed, you'll notice that two additional module slots are still available. Each of these module slots can accept one station module. Follow the instructions to install one or two station modules. The controller will automatically recognize the additional station capacity.



CAUTION: Be careful not to bend the pins in the sockets when installing the module.

- 1 Orient the connector on the bottom of the SM75 module with a connection socket on the controller backplane.

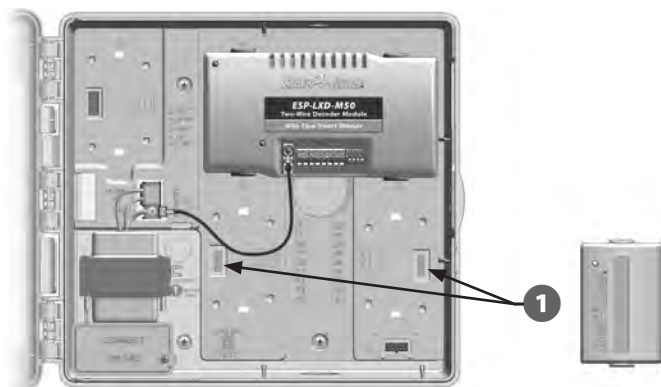

- 2 Carefully fasten the module onto the controller backplane, pressing firmly until it snaps into place.



- !** **NOTE:** To remove the module again, press in on the (two) release buttons on either side of the module.

Connect Field Wiring

The ESP-LXD controller can support up to four 2-Wire connections. The controller will manage multiple 2-Wire connections as a single 2-Wire path. The cable must be approved for underground use. Rain Bird recommends use of MAXI Cable, #14 AWG, as your 2-Wire communications cable.

Connecting the 2-Wire Cable

- !** **NOTE:** If installing communications wiring for IQ Software and/or ET Manager, do not install the communications cables in the same conduit as the 2-Wire path wiring.

- 1 Strip away approximately 6 in (15,24 cm) of the cable's outer sheathing; then strip approximately 5/8 in (1,58 cm) of the insulation away from the ends of the two inner wires. See Wire Splices and Field Decoder Connections for more details on the correct way to splice wire connections.

- 2 Locate (or remove) the large knockout on the bottom of the controller cabinet. Attach a conduit fitting to the bottom of the cabinet; then attach conduit to the fitting.
- 3 Feed the 2-Wire communications cable through the conduit and into the controller cabinet.

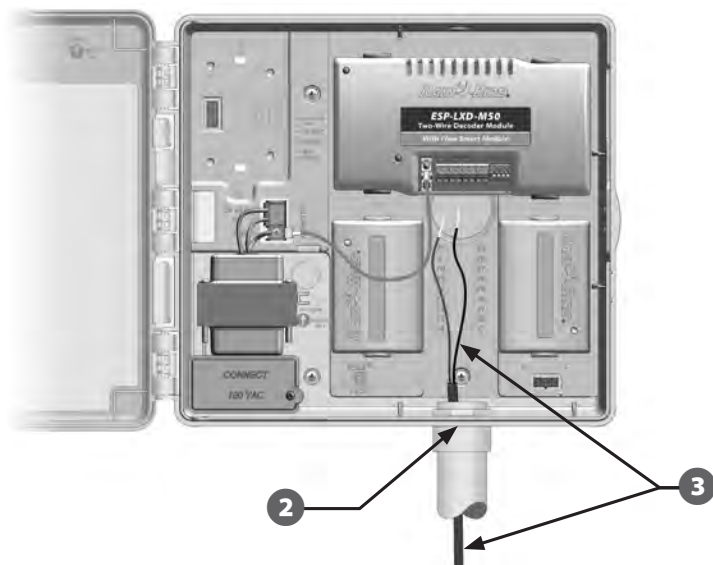

- 4 Using a thin blade screwdriver, connect the two wire ends to a set of large two-wire path terminals on the ESP-LXD decoder module. When finished, tug gently on the wires to make sure the connections are tight.

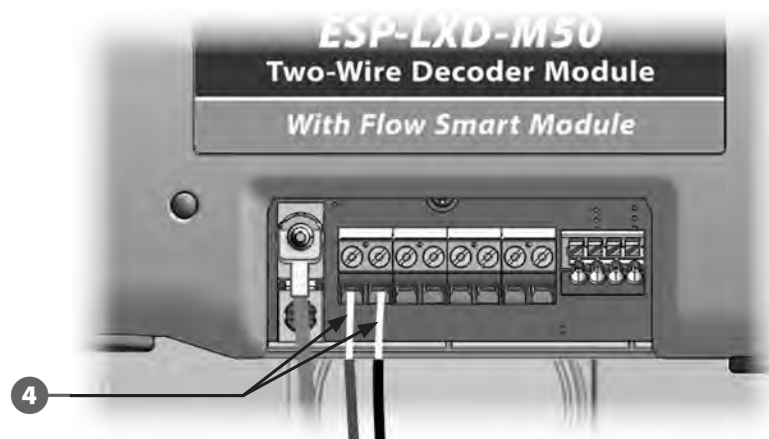

- ↻ If you have multiple two wire paths then repeat this process to connect those wire ends to the other LXD module terminals as desired.

- 5 Once wiring is completed, fill top of conduit with waterproof caulking to prevent insect intrusion into the controller cabinet.

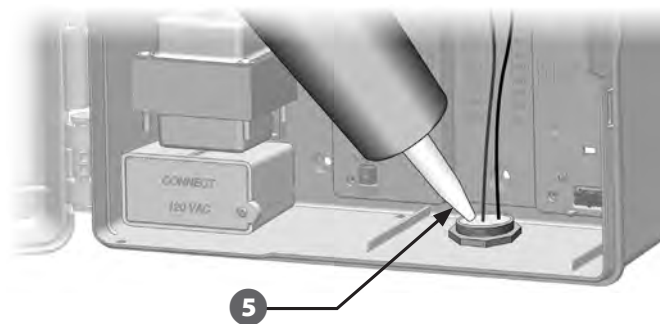

Connecting Power to the Controller

Connect Ground Wire

The ESP-LXD controller is equipped with built-in electrical surge protection. For this system to function, you must properly ground the controller.

⚡ WARNING: The ground wire **MUST** be connected to provide electrical surge protection. Connect the controller to the grounding grid using at least a #8 AWG (10 mm) or #10 AWG (6 mm) bare copper wire. The wires should be as short and as straight as possible. You will void the controller warranty if you do not ground the controller to a minimum resistance of five ohms.

Connect Power Source

The ESP-LXD controller has an internal transformer that reduces supply voltage (120 VAC in U.S. models; 230 VAC in international models; 240 VAC in Australian models) to 24 VAC to operate the decoders connected to the controller. You will need to connect power supply wires to the transformer's three wires.

⚡ WARNING: Electric shock can cause severe injury or death. Make sure power supply is turned OFF before connecting power wires.

⚡ WARNING: All electrical connections and wiring runs must be made according to local building codes.

- 1 With the front panel removed, locate the transformer wiring compartment in the lower left corner of the controller cabinet. Remove the screw on the right-hand side and pull the cover off to expose the wiring compartment.

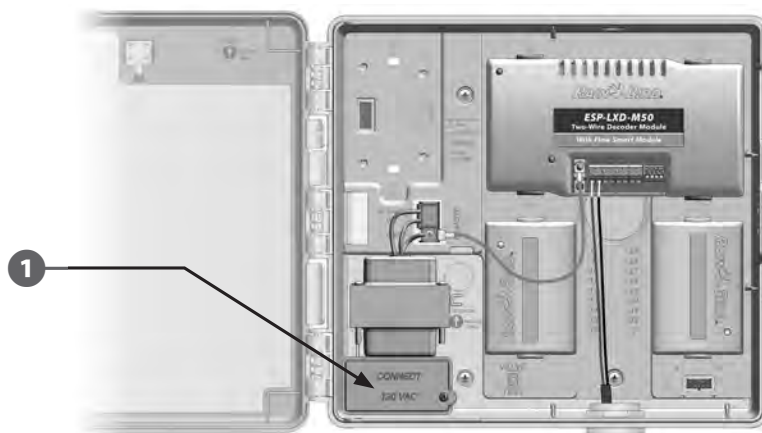

Wiring Connections	
120 VAC (US)	230 VAC (International)
Black supply wire (hot) to the black transformer wire	Black supply wire (hot) to the black transformer wire
White supply wire (neutral) to the white transformer wire	Blue supply wire (neutral) to the blue transformer wire
Green supply wire (ground) to the green transformer wire	Green-with-yellow-stripe supply wire (ground) to the green-with-yellow-stripe transformer wire

- 2 Strip the insulation from the three incoming wires to expose approximately 1/2 in (13 mm) of bare wire.
 - 3 Remove the knockout on the bottom of the cabinet below the transformer and attach a 1/2 in (13 mm) conduit fitting to the bottom entrance of the wiring compartment.
- !** **NOTE:** 240 VAC (Australian) units do not require a conduit because the power supply cable is already installed.
- 4 Feed the three supply wires from the power source through the conduit into the wiring compartment.

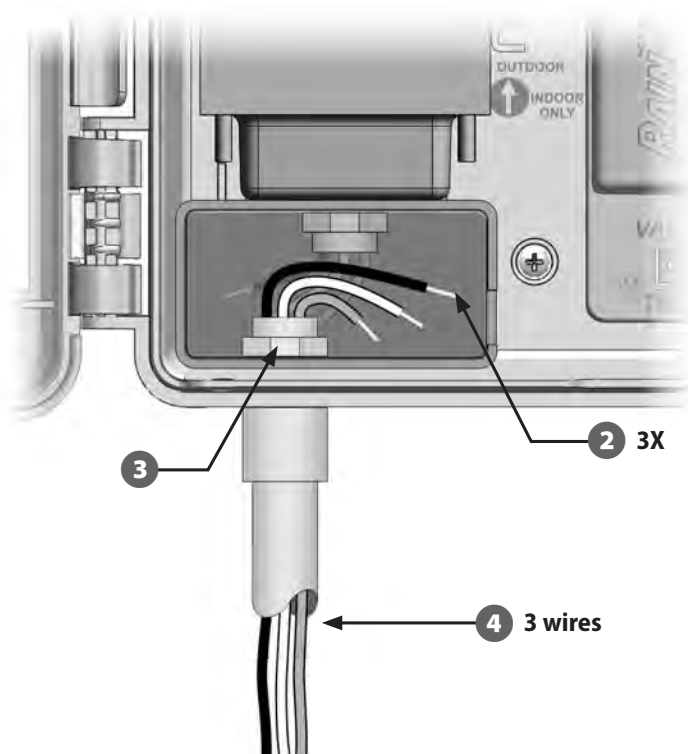

- 5 Using wire nuts, connect the wires accordingly.

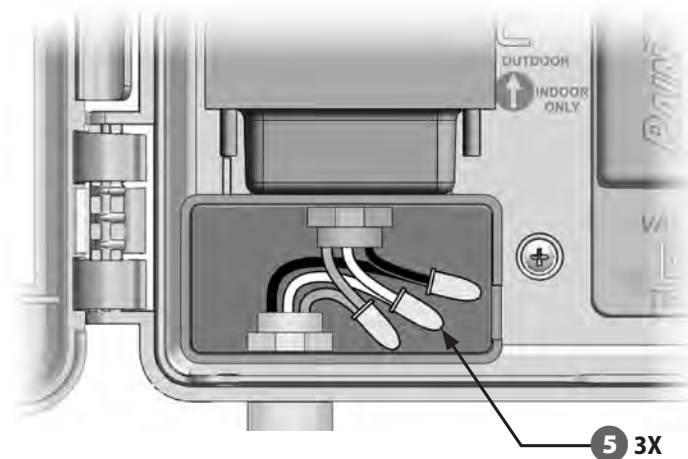

⚡ WARNING: The ground wire **MUST** be connected to provide electrical surge protection. You will void the controller warranty if you do not ground the controller.

- 6 Once wiring is completed, fill top of conduit with waterproof caulking to prevent insect intrusion into the controller cabinet.

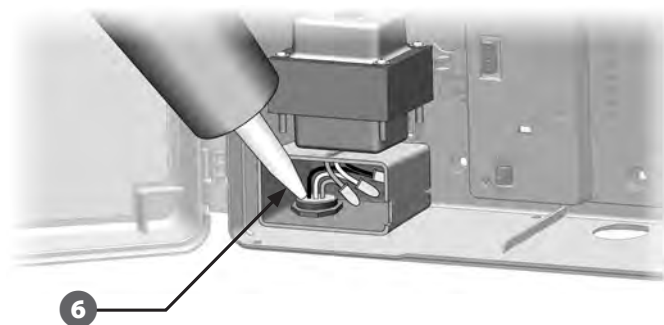

- 7 Verify that all connections are secure. Then replace the cover of the transformer wiring compartment and secure it with the screw.

Complete Installation

⚡ WARNING: To prevent electrical shock, make sure all supply power is OFF before completing installation. Electrical shock can cause severe injury or death.

1 If you removed the front panel, reinstall it now by inserting the top corner pin into the top pin-hole; then push up and rock the bottom corner pin into the lower pin-hole.

2 Reconnect the ribbon cable to the front panel by gently pushing the connector into the socket.

🚫 CAUTION: Be careful NOT to bend the pins in the socket.

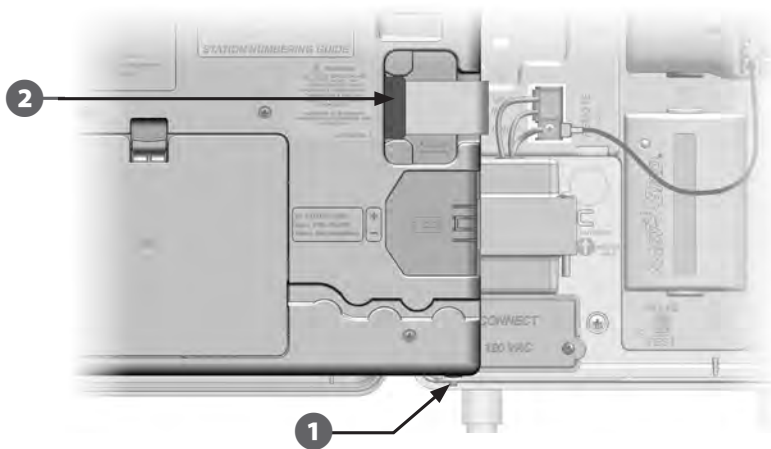

3 Turn on the power source.

! NOTE: The first time you power up the controller, the display will prompt you to select the language you wish to use. See Section E, Set Language for more details..

Programming Under Battery Power

The ESP-LXD controller front panel can operate under battery power for remote programming. This feature is especially useful if the controller is installed in an area that is not easily accessible. It also lets you enter program information before installing the controller at the job site. All program information is stored in nonvolatile memory so it will be preserved indefinitely in the event of a power outage.

! NOTE: Under battery power, all programs in progress will continue to run in memory, but irrigation will not occur until power is restored. Without battery power, remaining programs will be cancelled.

4 Install a new 9-volt battery in the battery compartment in the back of the front panel.

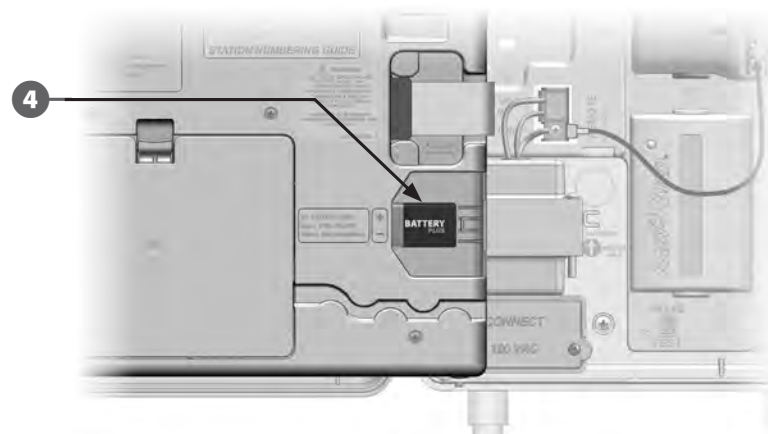

! NOTE: To perform remote programming, detach the front panel from the cabinet. See Access Controller Cabinet for more details.

🚫 CAUTION: The controller can not run irrigation or system diagnostics with the front panel detached. Re-connect the front panel to the controller's AC power source as soon as remote programming is completed.

Connect Decoders to Field Wiring

All valves must be connected to field decoders for irrigation management by the controller. Decoders must be wired both to a valve and by splicing to the 2-Wire path. Splices and field decoders should always be placed in valve boxes (except when valve-in-head sprinklers are used, which can be directly buried).

! **NOTE:** Before installing field decoders, remove the barcode address label from each decoder and attach it to the proper station (or device) number field in the Programming Guide. See Programming Guide instructions for more details.

Wire Splices

! **NOTE:** Label any wires that will be spliced in case troubleshooting is required later.

- 1 Strip away approximately 6 in (15,24 cm) of the cable's outer sheathing. Rain Bird recommends use of a MAXI cable jacket stripper for this task. The stripping should be done by carefully scoring the outer jacket in at least two places and then gently flexing the cable to loosen the portion of the outer jacket to be removed. It may be necessary to remove the outer jacket in two or more sections.
- 2 Once the red and black inner wires are exposed, use a wire stripper to strip approximately 5/8 in (1,58 cm) of the insulation away from the ends of the two inner wires.

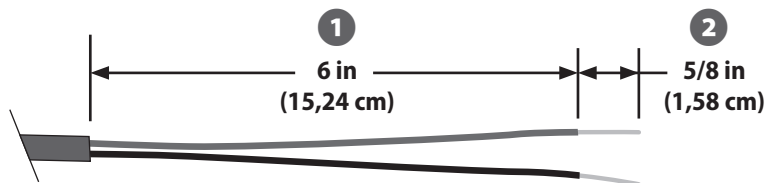

Splice for 2-Wire Cable

- 3 If a splice is needed to support an additional connection to MAXI cable, connect the inner red wire to the additional cable red wire and the black wire to the black wire, using linesman's pliers to gently twist the wires together three or four times. Insert the connections into an approved direct bury splice kit.



WARNING: Use only Rain Bird DB (direct burial) or 3M DBR/DBY splice kits for all electrical wiring connections to the 2-Wire path. Improper wiring can cause serious damage to your controller or irrigation system.

Field Decoder Connections

- 1 Splice one decoder blue wire to the 2-Wire path red wire; then splice the other decoder blue wire to the 2-Wire path black wire.

If the decoder is NOT at the end of the two wire path then make a three-way splice; one blue wire from the decoder to the two red wires in the two wire path; then splice the other blue decoder wire to the two black wires in the two wire path.

- 2 Splice additional wires from the decoder to the valve or valves to be controlled, using a pair of the same color wires for each valve. For example, Rain Bird FD-101 field decoders control a single valve and have a pair of white wires for connection to the valve. Other Rain Bird field decoders are capable of controlling multiple valves. For example, the FD-601 has six additional pairs of wires for connection to up to six different valves.

! **NOTE:** When using field decoders capable of controlling multiple valves, note the wire color combination and decoder address combinations on the side of the decoder. Be sure to connect the wires to the different valves in the order you want your valves controlled, and be sure to affix the decoder labels to your Programming Guide in the same order.

- 3 Complete the splices to each valve by inserting the field decoder-to-valve splices into an approved direct bury splice kit.

⚡ **WARNING:** Use only 3M DBR/Y splice kits for all electrical wiring connections to the 2-Wire path. Improper wiring can cause serious damage to your controller or irrigation system.

- 4 For future troubleshooting or modifications, it is recommended to leave an additional 3 feet of 2-Wire cable stored in each valve box location.

! **NOTE:** For secondary wire run, the distance between the field decoder and the solenoid (valve) can not exceed 450 feet (137 meters) using 14 gauge wire.

Master Valves and MV Decoders

Up to five master valves can be connected to the ESP-LXD controller through field decoders attached to the two wire path. Master valves are connected to field decoders using the same processes as described previously. Be sure to attach the decoder barcode label to the Programming Guide as a master valve decoder instead of a normal station decoder.

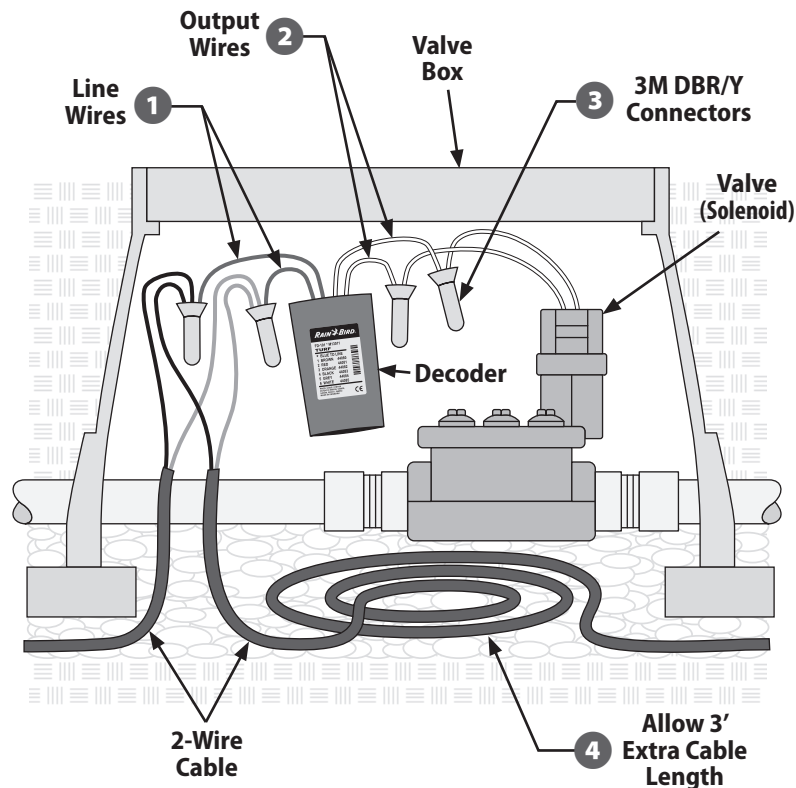

Typical Field Decoder Wiring

Surge Protection and Grounding



WARNING: The ESP-LXD controller and the 2-Wire path must be properly surge protected and grounded. Doing so can help prevent damage to the controller and irrigation system and also significantly reduce troubleshooting, repair time and expense. Failure to do so could result in failure of your controller and voiding the warranty.

Rain Bird requires the 2-Wire path to be surge protected and grounded with one LSP every 500 feet or every 8 decoders, whichever is smaller. Ensure that all grounding devices are compliant with local electrical codes.

Install Lightning Surge Protectors (LSP-1s)

- 1** Using a design drawing or as-built diagram for your installation system, determine the number of LSP-1s required and where they will need to be installed.
- 2** At the first LSP-1 location, install a grounding device, typically a grounding rod or plate, which meets all local codes, near the 2-Wire path.
- 3** Splice the blue wires from a Rain Bird LSP-1 to the 2-Wire path in the same manner as the installation of a field decoder detailed above, completing the splices with an approved direct-bury splice kit.
- 4** Connect the ground wires from the LSP-1 to the grounding device and install the LSP-1 inside a valve box.
- 5** Repeat this process to install all other LSP-1s as needed, noting their locations on your as-built diagram and/or design drawings.





NOTE: LSP-1s do not have decoder addresses, so it's not necessary to capture this information from your LSP-1s. For this reason, LSP-1s also do not have peel-off barcode labels for the Programming Guide. LSP-1s do not need to be recognized by or programmed into the controller or noted on the Programming Guide.

Decoder Managed Flow Sensors

Flow sensors are managed with SD-210 sensor decoders attached to the 2-Wire path. The ESP-LXD controller can support and manage up to five flow sensors.

Connect Flow Sensors

- 1 Install the flow sensors into your irrigation piping system.
-  **NOTE:** For optimum performance and flow sensing, flow sensors should be installed a minimum of 10 pipe diameters in length on the upstream (supply) side and a least 5 pipe diameters in length on the downstream (delivery) side before making any transitions in pipe size/direction or away from any valve.
- 2 For flow sensing, a Rain Bird SD-210 sensor decoder should be used in a valve box with proximity to a grounding device, the 2-Wire path and the flow sensor.
-  **NOTE:** If a grounding device is not present, install one, ensuring compliance to all local codes.
- 3 Follow the field decoder installation process to splice the two blue wires from the flow sensor to the red and black wires in the two wire path, completing the splice with approved direct burial splice kits.
- 4 Attach the green and yellow wires from the sensor decoder to the grounding device.
- 5 Splice the red and black wires from the SD-210 sensor decoder to the flow sensor. Be sure to follow all instructions included with the flow sensor. Complete the splices with approved direct burial splice kits.
- 6 Carefully peel the sensor decoder barcode label off of the sensor decoder and affix it into the flow sensor section of the Programming Guide.

Decoder Managed Weather Sensors

In addition to five flow sensors, ESP-LXD can also support three decoder-managed weather sensors. Rain Bird SD-210 sensor decoders are used and installed in exactly the same way. To install decoder-managed weather sensors, repeat this process but connecting the SD-210 sensor decoder to the weather sensor instead of to a flow sensor.

Local Weather Sensors

ESP-LXD can also accept input from a single weather sensor wired directly in to the controller instead of to the 2-Wire path. Supported Rain Bird sensors include the RSD rain sensing device, the WR2-RC wireless rain sensor, the WR2-RFC wireless rain/freeze sensor and the ANEMOMETER wind sensor (the Rain Bird 3002 Pulse Transmitter is required for use of the ANEMOMETER). Other generic sensors, such as soil moisture sensors will also typically work. ESP-LXD supports one local weather sensor. The local weather sensor can also be bypassed with the sensor bypass switch on the controller front panel.

Connect Local Weather Sensors

! **NOTE:** Follow the sensor manufacturer's instructions to correctly install and make wire connections to the sensor. Ensure the sensor installation is in compliance with all local codes.

- 1 Run continuous sensor wires from the weather sensor to the ESP-LXD controller.
- 2 Remove the yellow jumper wire (if present). Connect the sensor wires to the sensor (Sen) and common (C) inputs, to the right of the 2-Wire path terminals on the ESP-LXD decoder module. When finished, tug gently on the wires to make sure the connections are tight.

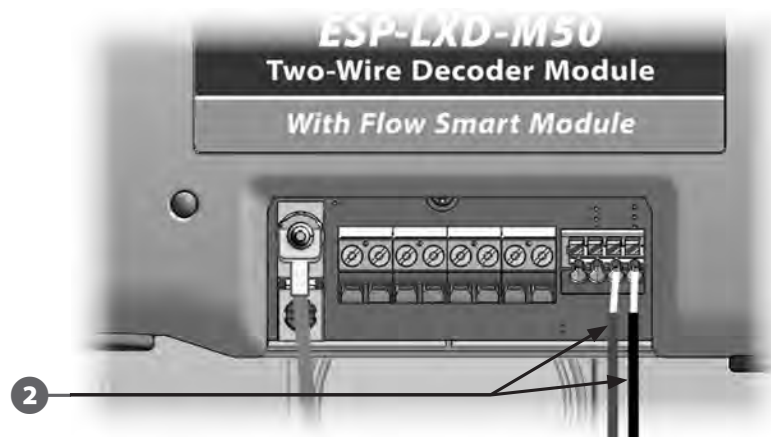

! **NOTE:** If your weather sensor requires 24V power from the controller, the connectors to the left of the sensor and common connectors can be used.

- 3 To enable the weather sensor: on the controller front panel, slide the Weather Sensors switch to Active.



! **NOTE:** Ensure that the configuration for your controller and irrigation programs are set up correctly for your sensor. For example, if one of your programs is set up to manage your landscape lighting you may want to ensure that its stations ignore input from a local rain sensor. See Section B, Weather Sensors Setup for more details.

! **NOTE:** The Weather Sensors switch activates or bypasses all installed weather sensors on your system.

Verifying Field Installation

Once some or all field decoders have been installed and programmed into the ESP-LXD controller you can check the electrical portion of the installation even if water is not available to test sprinklers. See Section C, Run a Line Survey for more details.

If water is available and you would like to test some or all of your sprinklers, the easiest way to do so is by using the Manual Watering features of the controller. See Section G, Manual Watering for more details.

this page intentionally left blank

Appendix

Electrical Requirement Code of Magnetic Solenoid

SWITCH CODE DEFINITION 59 F, X, Y, 0

Activation Time [ms]	X	Y	Holding Voltage [Volts]
30	3	3	1.2
40 →	4	4	1.7
50	5	5 ←	2.3
60	6	6	2.9
70	7	7	3.5
80	8	8	4.0
90	9	9	4.6
100	A	A	5.2
110	B	B	5.8
120	C	C	6.3
130	D	D	6.9
140	E	E	7.5
150	F	F	8.1

Use the chart above to select a suitable electrical code for special solenoid (valve) types.

! **NOTE:** To find a switch code that works with your valve, you may need to use the trial and error method.

Example:

Arrows in chart show:

Activation Time = **40** ms. (milliseconds)
Holding Voltage = **2.3** volts
Switch Code = **59F450**

If the solenoid opens but will not stay open, the holding voltage may be too low. Here, you would change the fifth digit of the code.

Example:

Arrows in chart show:

Activation Time = **50** ms.
Holding Voltage = **5.2** Volts
Switch Code = **59F5A0**

If the solenoid opens but will not stay open, the holding voltage may be too low. Here, you would change the fifth digit of the code.

Master Valve and Pump Set-up Tips

To supply water to the various valves located throughout an irrigation area, systems may use either a master valve or master pump. By recognizing a specific **Address** and switch code, the controller sends a signal telling the decoder when to activate the master valve or pump. The switch code can vary depending on how your system was installed. Below, we will cover some of the more common installations.

Using a Field Decoder With a Pump Start Relay

In this installation, a field decoder attaches to a pump using a pump start relay. When setting up the controller, enter the field decoder **Address** in the master valve **Address** field.

! **NOTE:** Rain Bird recommends use of a FD-101 for small pump start relays and a FD-102 for pumps 3/4 HP or greater.

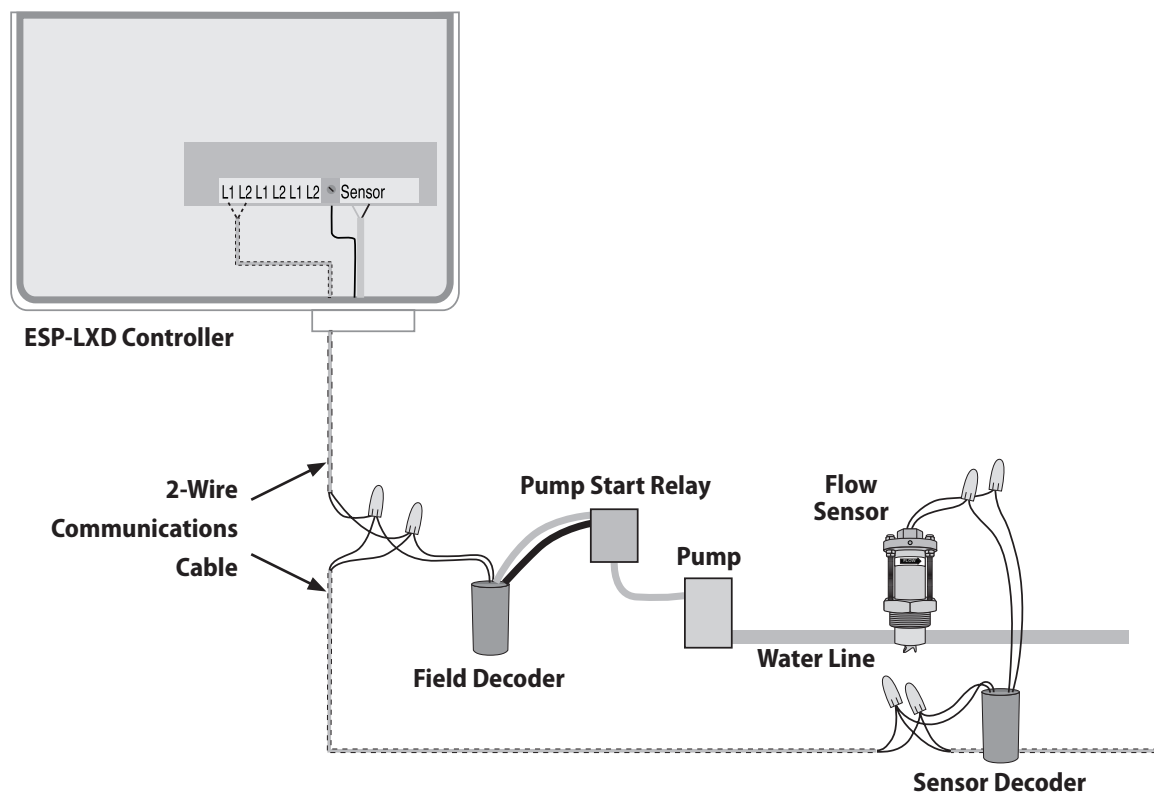

Declaration of Conformity

Application of Council Directive: 2004/108/EC

**Standards To Which
Conformity Is Declared:** EN55014-1: 2001 Class B
EN55022 Radiated Emissions
EN55022 Conducted Emissions
EN61000-3-2
EN61000-3-3
EN55014-2: 2001
EN61000-4-2
EN61000-4-3
EN61000-4-4
EN61000-4-5
EN61000-4-6
EN61000-4-8
EN61000-4-11

Manufacturer's Name: Rain Bird Corporation
Manufacturer's Address: 9491 Ridgehaven Court
San Diego, CA 92123
619-671-4048

Equipment Description: Irrigation Controller
Equipment Class: Requirements for household
appliances, electric tools and
similar apparatus

Model Numbers: ESP-LXD

*I the undersigned, hereby declare that the equipment specified
above conforms to the above Directive(s) and Standard(s).*

Place: Tucson, AZ USA

Signature:

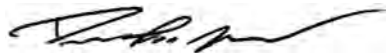

Full Name: Ryan L. Walker

Position: Director



RAIN BIRD CORPORATION
6991 E. Southpoint Road
Tucson, AZ 85756

© 2012 Rain Bird Corporation

® "Rain Bird", "SimulStations", "FloManager", "FloWatch", "FloZone" and "Cycle+Soak"
are registered trademarks of Rain Bird Corporation. All rights reserved.

www.rainbird.com